

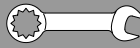

DIN EN  
806

DIN EN  
1717

DIN  
1988

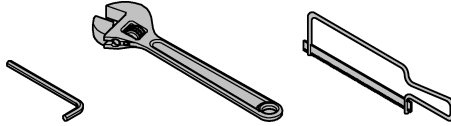
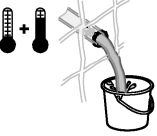
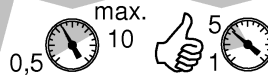

1

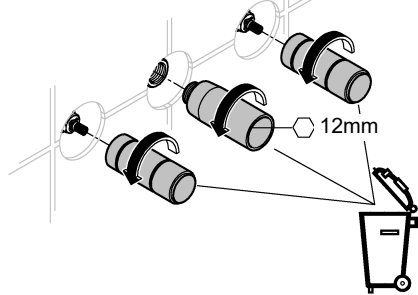
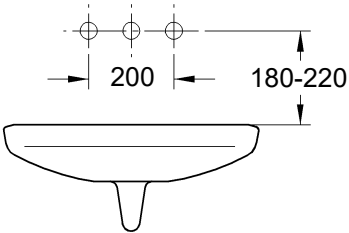

2

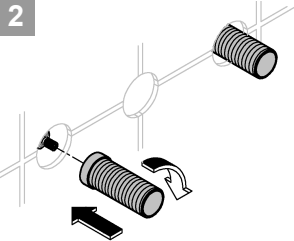

3

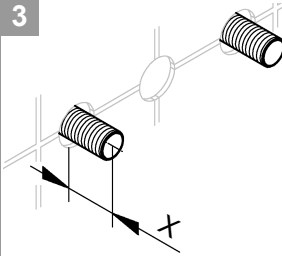

4

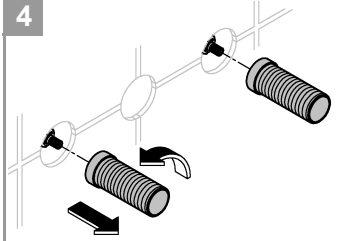

5

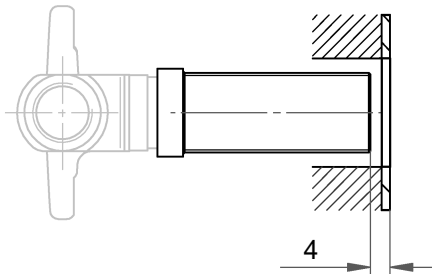
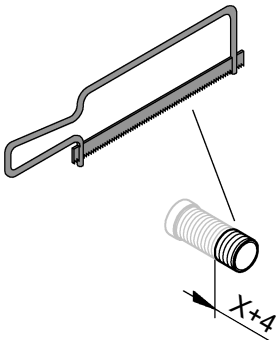



6

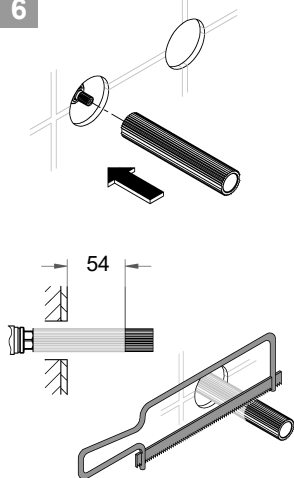

7

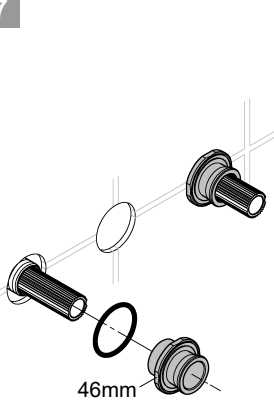

8

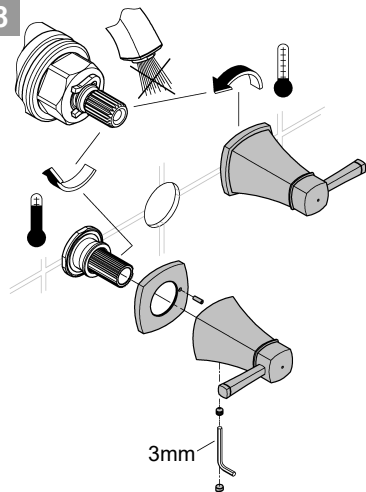

9

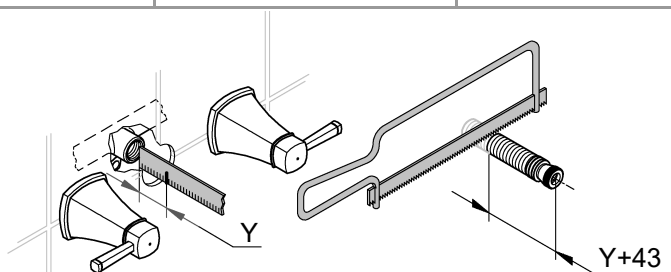

10

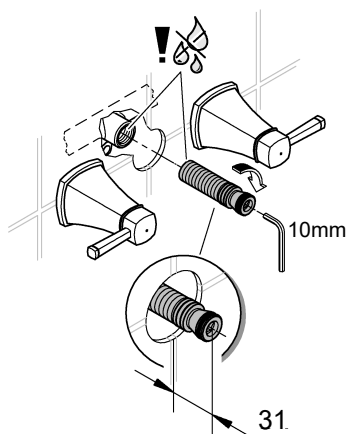

11

