

sunshower®
health & wellbeing



DELUXE
WHITE / BLACK / ORGANIC GREY

INSTALLATION GUIDE
PART **I** - PREPARATION



P.2



P.15



P.28



P.41



P.54



SCAN ME!



DELUXE
WHITE / BLACK / ORGANIC GREY

INSTALLATION GUIDE

PART 1 - PREPARATION

GENERAL INSTRUCTIONS



GENERAL

BE SURE TO READ THIS INSTRUCTION CAREFULLY BEFORE INSTALLATION. INSTALLATION CAN ONLY BE CARRIED OUT BY QUALIFIED INSTALLERS. THE ELECTRICAL CONNECTION OF SUNSHOWER COMPONENTS CAN ONLY BE CARRIED OUT BY QUALIFIED ELECTRICIANS. SUNSHOWER IS NOT LIABLE FOR DAMAGE CAUSED BY INCORRECT INSTALLATION.



ELECTRICITY

THE ELECTRICAL CONNECTION OF SUNSHOWER COMPONENTS MAY ONLY BE CARRIED OUT BY A QUALIFIED ELECTRICIAN. THE INSTALLATION AND ELECTRICAL CONNECTION OF THE SUNSHOWER INSTALLATION MUST BE CARRIED OUT IN ACCORDANCE WITH THE APPLICABLE INTERNATIONAL AND NATIONAL STANDARDS AND GUIDELINES. THE SUNSHOWER MUST BE PROTECTED BY A SEPARATE EARTH LEAKAGE CIRCUIT BREAKER (RCD) (SEE ELECTRICAL CONNECTION).

Sunshower B.V.
Hoogoorddreef 63-65
1101 BB Amsterdam
The Netherlands

T +31 (0)20 462 14 60
www.sunshower.eu
info@sunshower.nl

DECLARATION OF CONFORMITY

Sunshower B.V., Hoogoorddreef 63-65, 1101 BB Amsterdam (The Netherlands) hereby declares, under our sole responsibility, that the Sunshower DELUXE is in accordance with the conditions of the following directives:

- Low-Voltage Directive 2014/35/EU
- Directive 2014/30/EU for Electromagnetic compatibility of the European Parliament

And is in conformity with the following standards:

- EN60335-1:2012 + A11:2014 + AC2014 + A13:2017 + A1:2019 + A2:2019 + A14:2019
- EN60335-2-27:2014 + A1:2020 + A2:2020
- EN61000-6-3:2007 + A1:2011 + AC:2012
- EN61000-6-1:2007
- EN61000-6-1:2019
- EN61000-3-3:2013
- EN61000-3-2:2014

This Sunshower product is IPX5 approved and specially designed for use and installation in zone 1.

The Netherlands, Amsterdam, 1 jan 2020

Signed for and on behalf of:



M. Wegdam, Technical Director



Sunshower B.V.
Hoogoorddreef 63-65
1101 BB Amsterdam
The Netherlands

T +31 (0)20 462 14 60
www.sunshower.eu
info@sunshower.nl

PREPARATION

BOX CONTENT

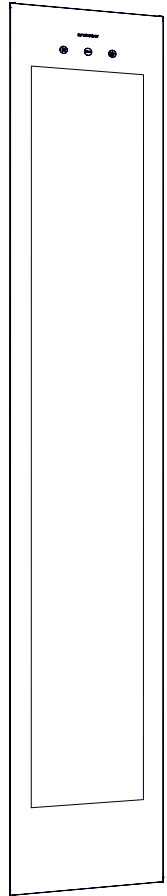

GLASS PANEL

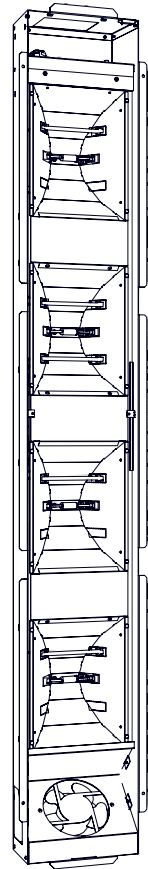

INNER UNIT

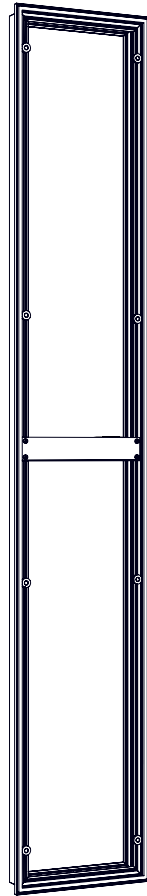

WALL FRAME

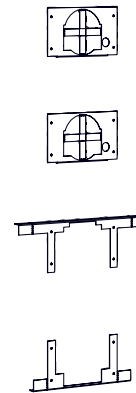

GUSSET PLATES +
CONNECTION SLEEVES

IN THE BOX

- Installation bag
- 2x Gusset plates
- 2x Connection sleeves
- 2x Glasses

NOT INCLUDED

- MS Polymer
- Measuring tape
- Screwdriver (+)
- Spirit level
- 2x Screws
- 2x Ventilation ducts (round/
rectangular), max. 3 m
- 8x Duct brackets
- 2x Ventilation grilles
- 2x (Non-return valves)

PREPARATION

DIMENSIONS

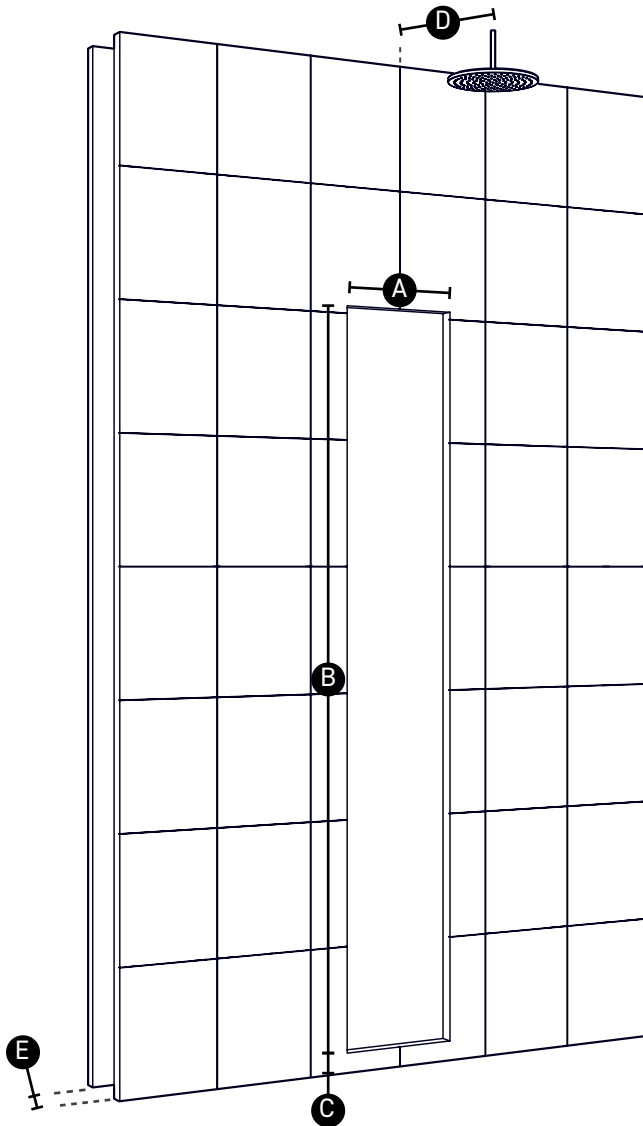

INSTRUCTIONS

Make the recess in the wall according to the dimensions shown.

REQUIRED TOOLS

- Measuring tape
- Spirit level

A	300 MM
B	1850 MM
C	100 MM
D	450 MM
E	MIN 165 MM <small>SEE P9 / P10</small>

PREPERATION

ELECTRICITY

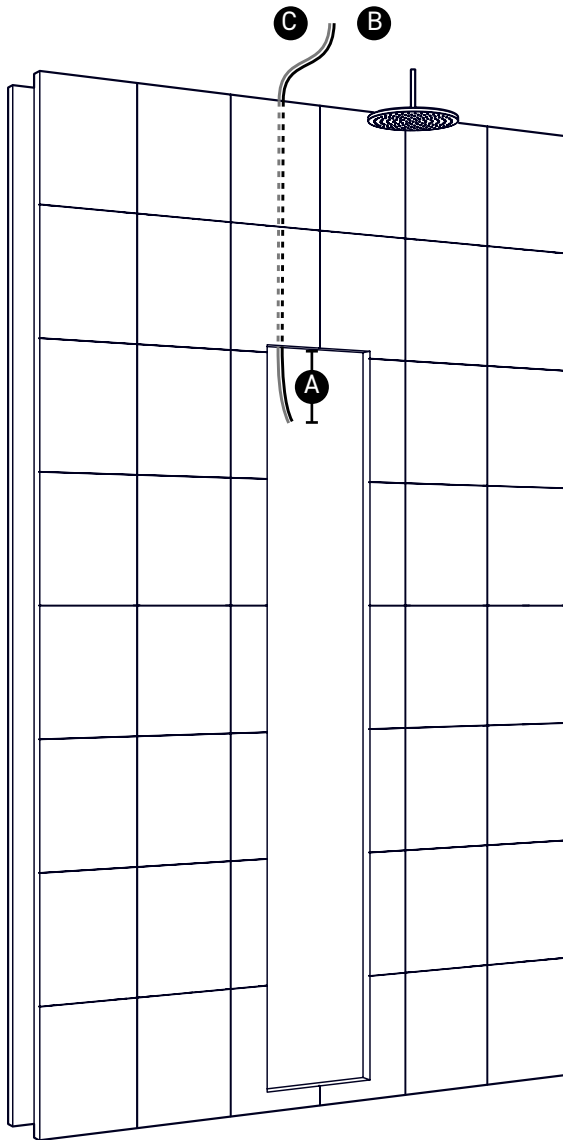

INSTRUCTIONS

Use a YmVc cable of at least 2.5 mm² and a equipotential bonding cable of 6 mm² without PVC pipe or 2.5 mm² with PVC pipe. The Sunshower should be connected to its own 230V~ 50Hz circuit fitted with a residual current circuit breaker (RCD 30mA) and a 16A fuse.



ALL ELECTRICAL WORK MUST BE CARRIED OUT BY A QUALIFIED ELECTRICIAN IN ACCORDANCE WITH THE APPLICABLE GUIDELINES (HD 60364-7-701 AND SUCH) AND NATIONAL REGULATIONS.

A SEPARATE POWER CONNECTION WITH A SEPARATE FUSE AND A SEPARATE EARTH LEAKAGE CIRCUIT BREAKER (RCD) MUST BE PROVIDED.

- A** 500 MM
- B** POWER SUPPLY, 3-CORE CABLE
- C** EQUIPOTENTIAL BONDING CABLE

PREPARATION

VENTILATION

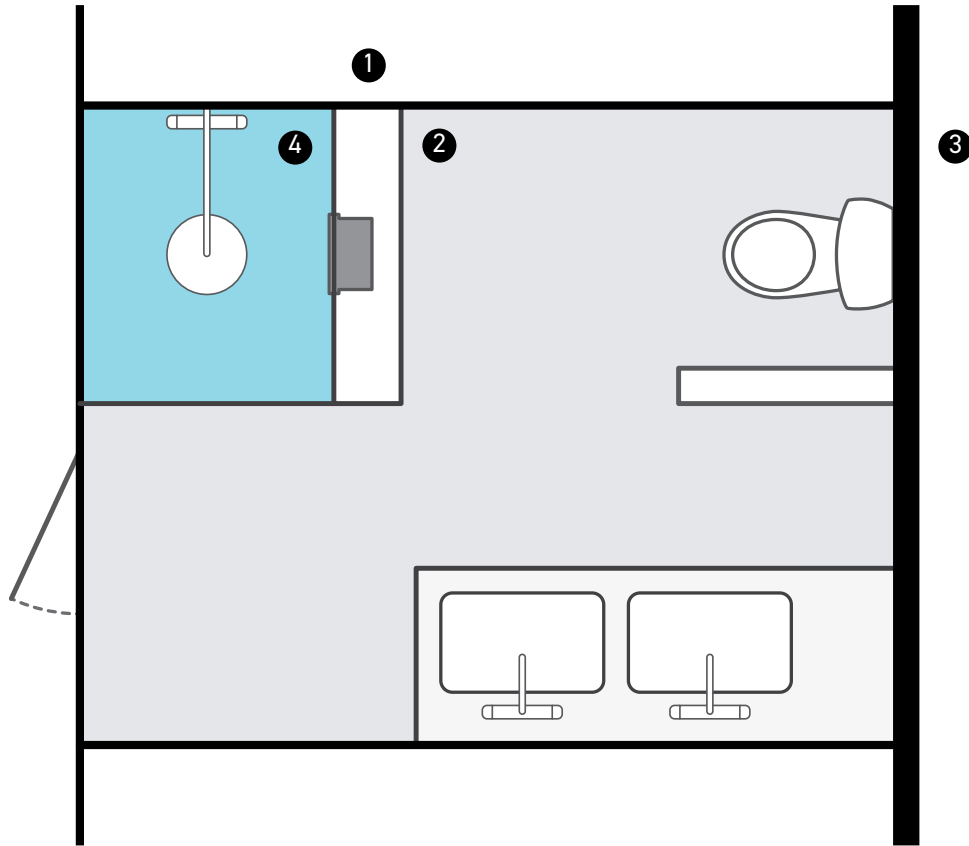

1	DRY AREA	A	PAGE 9	PREFERRED
2	BATHROOM	B	PAGE 10	
3	OUTSIDE	B	PAGE 10	
4	SHOWER AREA	-	-	NOT POSSIBLE

INSTRUCTIONS

GENERAL CONSTRUCTION

GUIDELINES:

- All Sunshower appliances must be installed with ventilation ducts
- Ventilation feed and exhaust can both be a maximum of 3 m
- The space from which/to which ventilation is provided must be at least 12 m³
- The ducts can be of any material, with dimensions Ø100 mm or 110 * 55 mm
- Make as few bends as possible in the ducts
- The Sunshower may not be connected to an existing ventilation system

NON-RETURN VALVES:

Non-return valves must be installed if the air for your Sunshower is extracted from a humid area, e.g. from the outside or from the bathroom. Please refer to the image and subsequent pages for instructions. The non-return valves can be ordered additionally (as a set with the glass panels) or can be purchased separately at your hardware store.

Examples of humid areas: bathroom, outside.

Examples of dry areas: bedroom, hallway, toilet.

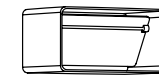

RECTANGULAR
NON-RETURN
VALVE

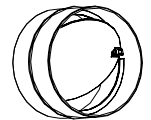

ROUND NON-
RETURN VALVE

INSTALLATION

A DRY AREA

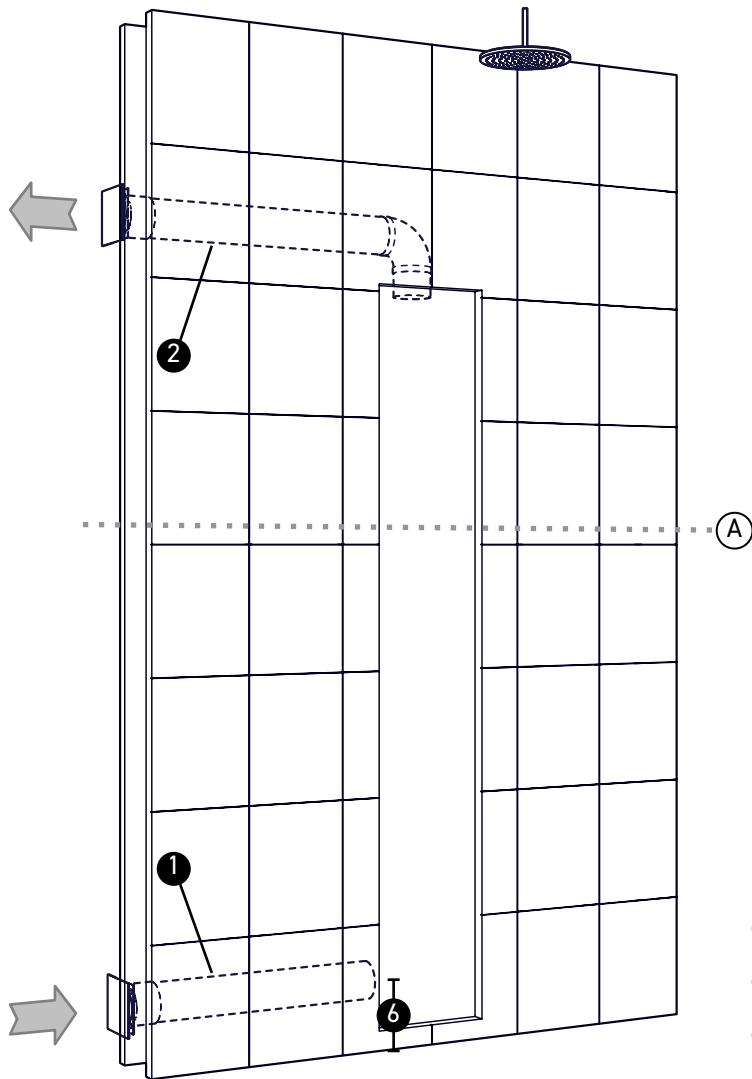

- ① Feed
- ② Exhaust
- ③ Back wall
- ④ Optional insulation
- ⑤ Wall construction (Drywall/Tiles/Hollow wall)

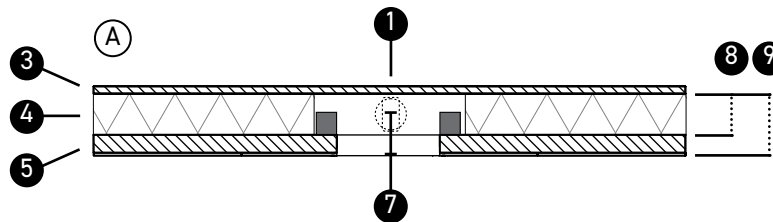

INSTRUCTIONS

Install ventilation ducts measuring at least $\varnothing 100$ mm or 110 x 54 mm with a maximum length of 3 m (both feed and exhaust). The ventilation feed space must be at least 12 m³.

In this case, non-return valves are not mandatory.

REQUIRED TOOLS

- 2x □ Ventilation ducts
- 8x □ Duct brackets
- 1x □ Ventilation grilles set (sold separately)
- 2x Ventilation grilles

Minimum inner dimensions (8)
 round ducts: 110 mm
 Minimum inner dimensions
 (8) rectangular ducts: 70 mm

- ⑥ 210 MM
- ⑦ 100 MM
- ⑧ 70 MM MIN.
- ⑨ 170 MM MIN.

INSTALLATION

B HUMID AREA

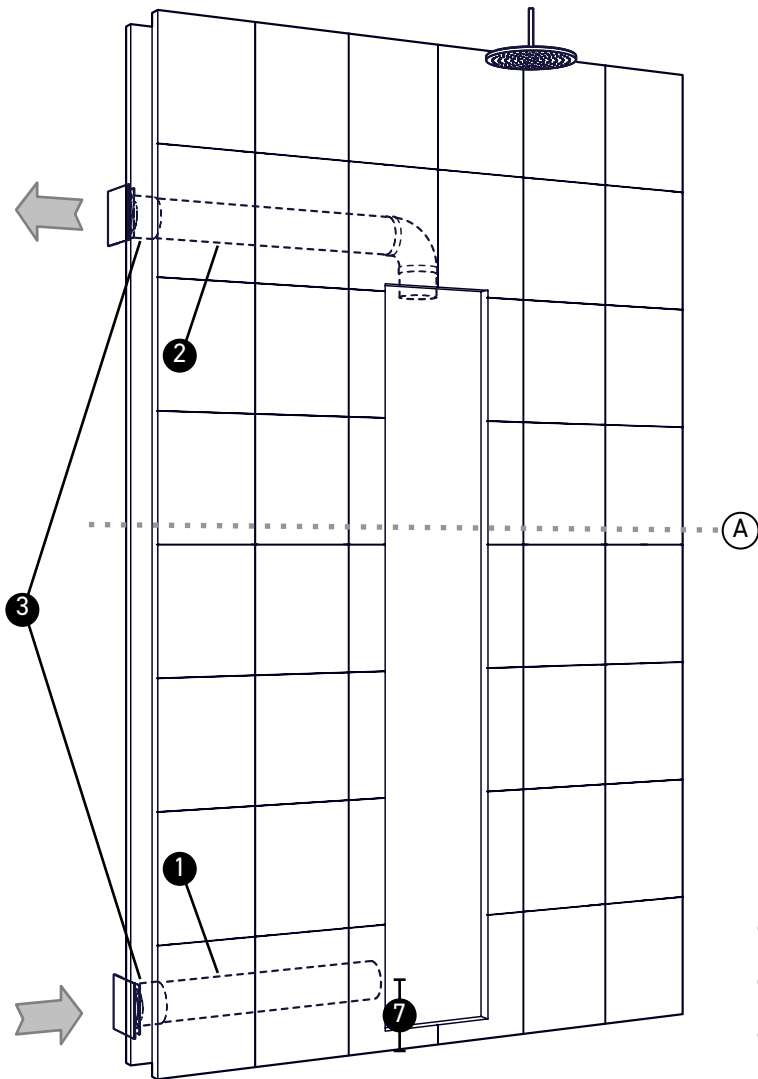

- 1 Feed
- 2 Exhaust
- 3 Non-return valves
- 4 Back wall
- 5 Optional insulation
- 6 Wall construction (Drywall/Tiles/Hollow wall)

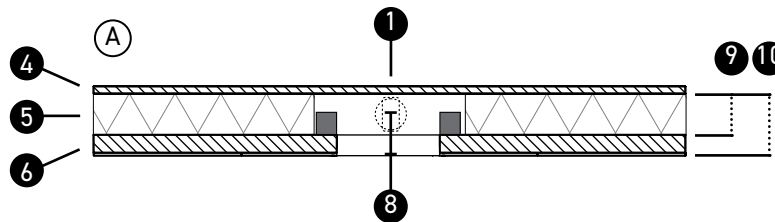

INSTRUCTIONS

Install ventilation ducts measuring at least $\varnothing 100$ mm or 110 x 54 mm with a maximum length of 3 m (both feed and exhaust). The ventilation feed space must be at least 12 m³.

In this case, non-return valves are mandatory.

REQUIRED TOOLS

- 2x Ventilation ducts
- 8x Duct brackets
- 1x Ventilation grilles set (sold separately)
- 2x Ventilation grilles
- 2x Non-return valves

Minimum inner dimensions (9)
 round ducts: 110 mm
 Minimum inner dimensions
 (9) rectangular ducts: 70 mm

- 7 210 MM
- 8 100 MM
- 9 70 MM MIN.
- 10 170 MM MIN.

INSTALLATION

WALL FRAME

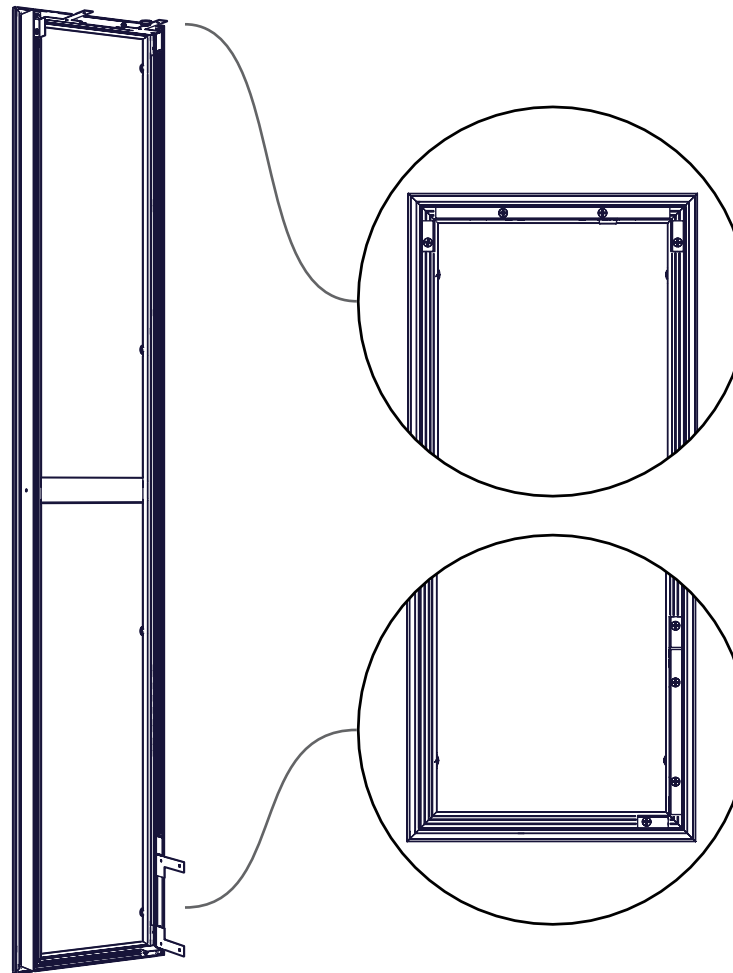
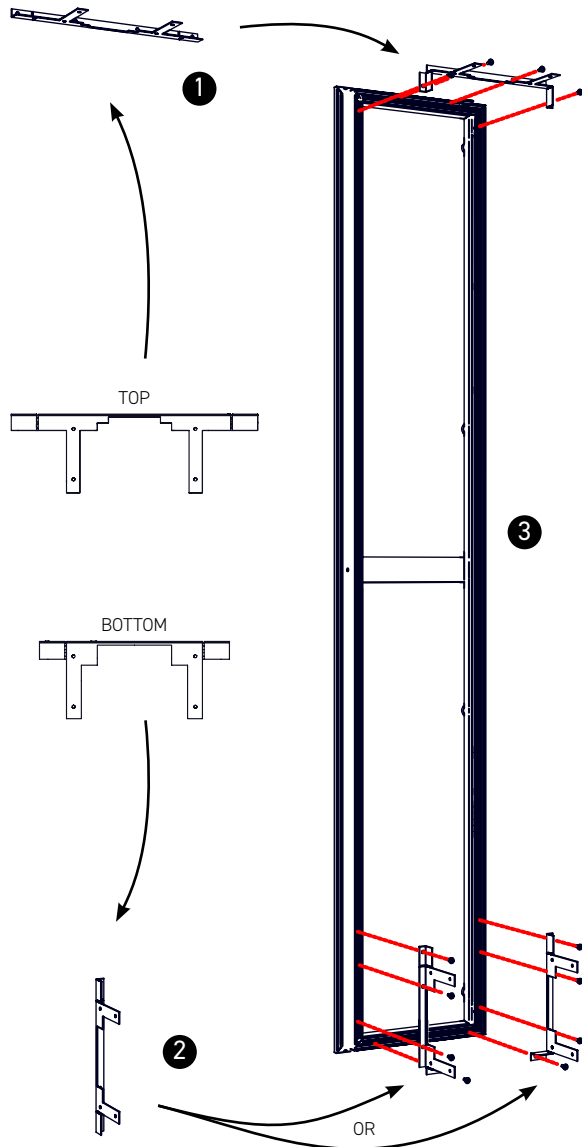

INSTRUCTIONS

- 1 Fold the upper gusset plate as shown
- 2 Fold the lower gusset plate as shown, depending on the side where the ventilation supply is to be installed
- 3 Mount both gusset plates at the top and bottom of the frame as indicated, using the screws provided

REQUIRED TOOLS

- Screwdriver (+)
- 2x Gusset plate
- 8x Screws

INSTALLATION

WALL FRAME

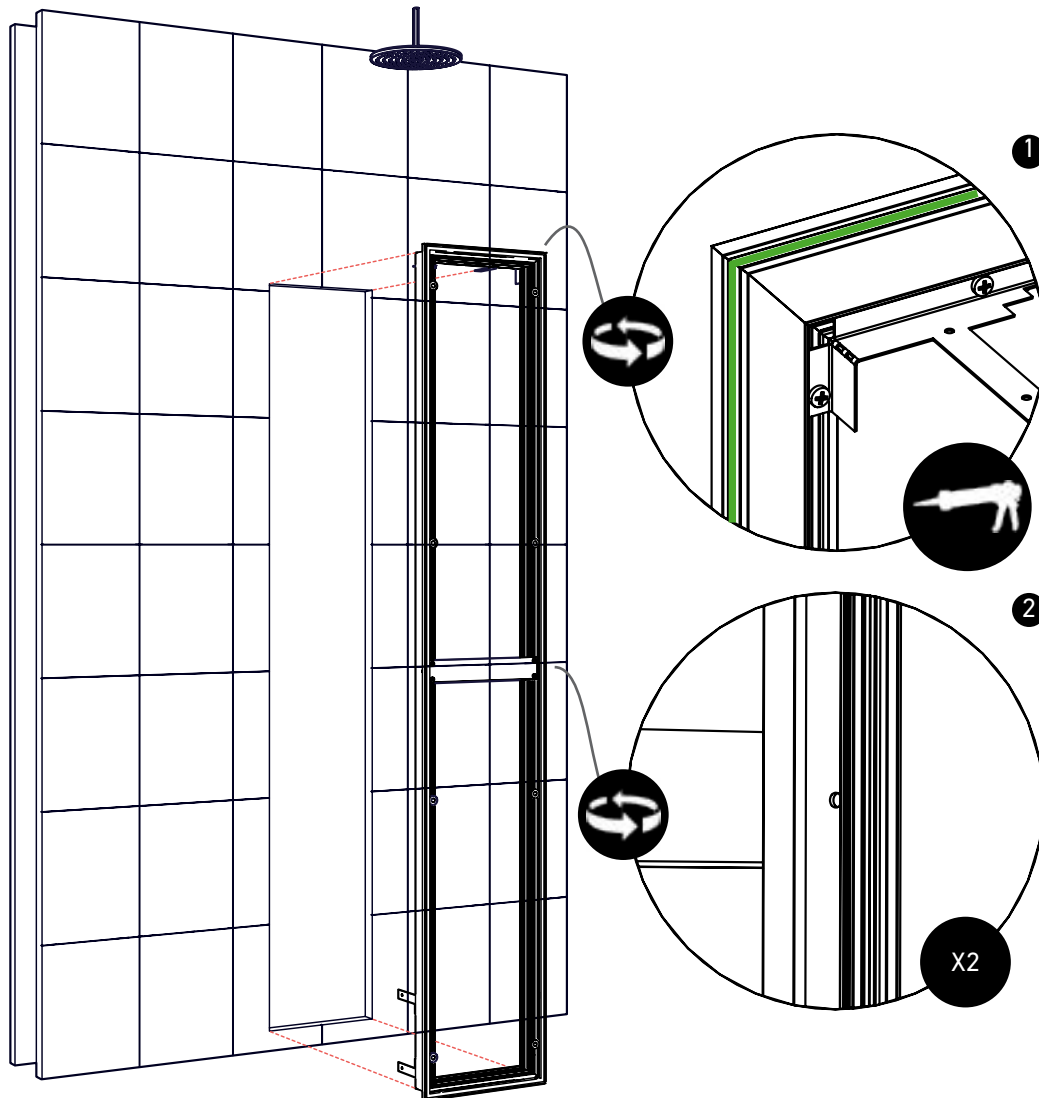

INSTRUCTIONS

Completely finish the wall before placing the frame; this gives the best result. Then install the frame:

- 1 Apply sealant to the rear of the wall frame, around the complete periphery
- 2 Screw the frame to the wall on both sides

REQUIRED TOOLS

- Sealant
- Screwdriver (+)
- 2x □ Screws



CAUTION:

These instructions are important to ensure the IPX5 seal

INSTALLATION

WALL FRAME

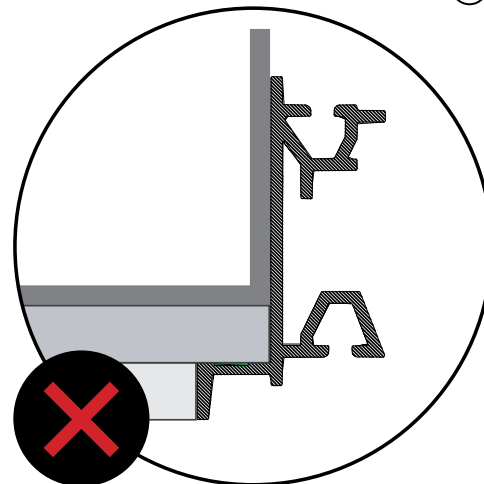
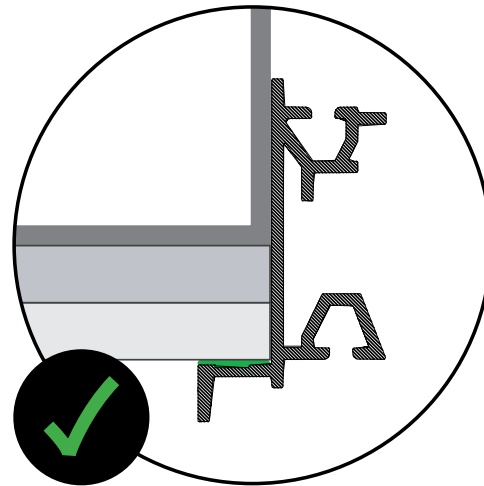
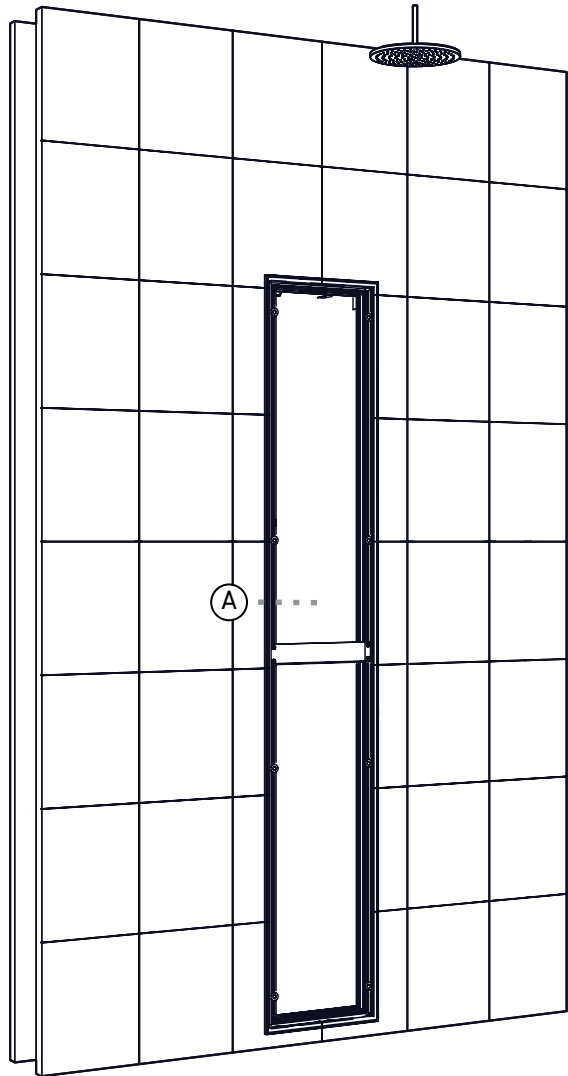

Make sure that the frames are mounted in the wall, instead of flush with the wall. This is to guarantee a watertight seal around the Sunshower.

INSTALLATION

WALL FRAME

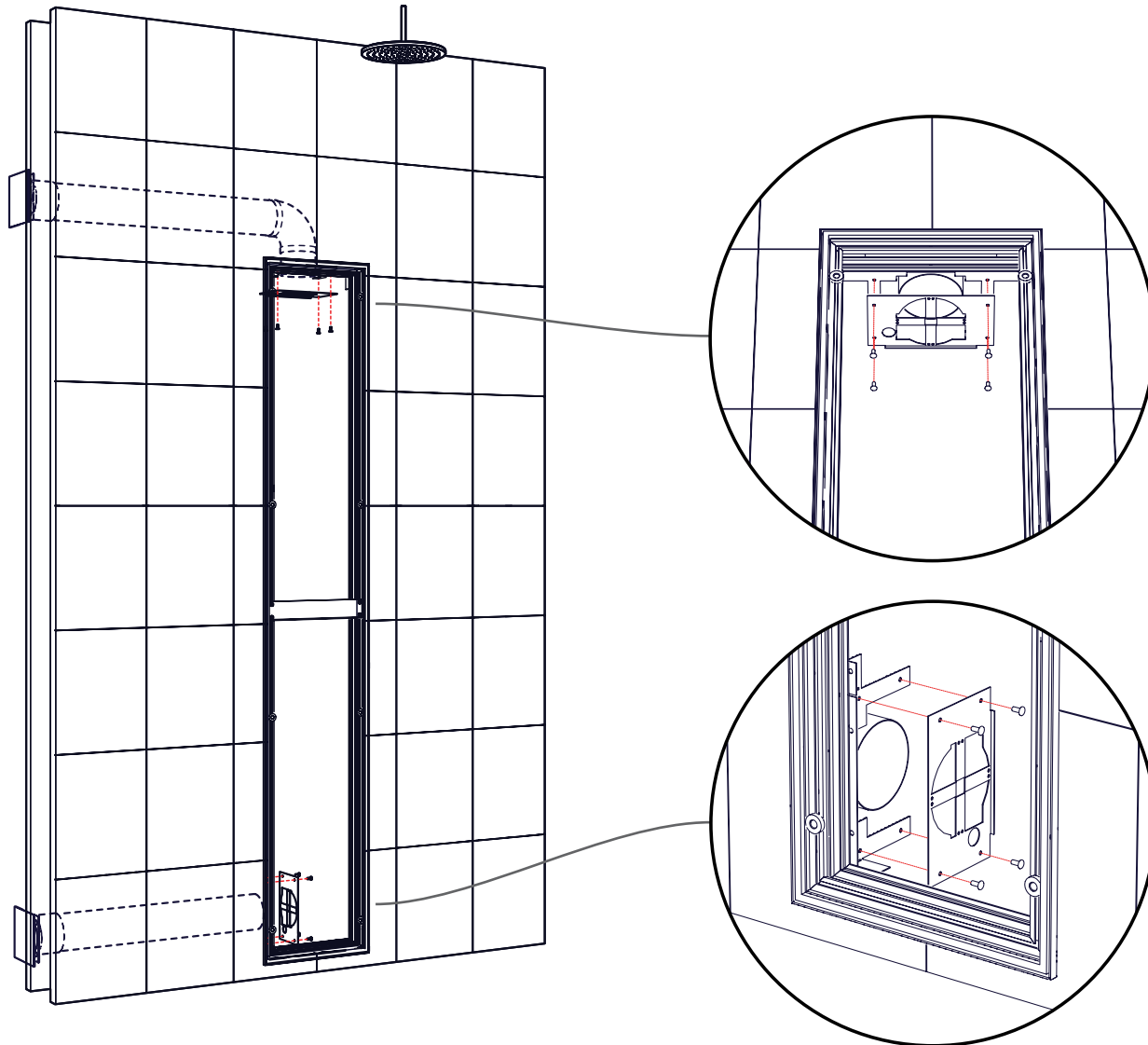

INSTRUCTIONS

Attach the connection sleeves to the gusset plates using the push-in rivets. Fold the lips of the connection sleeves back and slide them into the ventilation ducts.

You have now completed part 1 of the installation process. Leave the sealant to dry for 24 hours before starting part 2.

REQUIRED TOOLS

- 2x □ Connection sleeves
- 8x □ Push-in rivets



DELUXE
WHITE / BLACK / ORGANIC GREY

INSTALLATIEHANDLEIDING

DEEL ❶ - VOORBEREIDING

ALGEMENE INSTRUCTIES



ALGEMEEN

LEES DEZE INSTRUCTIES ZORGVULDIG DOOR VOORDAT U MET DE INSTALLATIE BEGINT. INSTALLATIE DIENT ENKEL UITGEVOERD TE WORDEN DOOR GESCHOOLD EN ERKEND VAKPERSONEEL. DE ELEKTRISCHE AANSLUITING VAN SUNSHOWER-COMPONENTEN MAG ALLEEN DOOR EEN ERKEND ELEKTRICIEN WORDEN UITGEVOERD. SUNSHOWER IS NIET AANSPRAKELIJK VOOR SCHADE VEROORZAAKT DOOR ONJUISTE INSTALLATIE.



ELEKTRA

DE ELEKTRISCHE AANSLUITING VAN SUNSHOWER-COMPONENTEN MAG ALLEEN DOOR EEN ERKEND ELEKTRICIEN WORDEN UITGEVOERD. DE MONTAGE EN ELEKTRISCHE AANSLUITING VAN DE SUNSHOWER-INSTALLATIE MOET WORDEN UITGEVOERD IN OVEREENSTEMMING MET DE GELDENDE INTERNATIONALE EN NATIONALE NORMEN EN RICHTLIJNEN (BIJVOORBEELD VOOR NEDERLAND: NEN 1010 - 701). DE SUNSHOWER MOET WORDEN BEVEILIGD DOOR EEN APARTE AARDLEKSchAKELAAR (RCD) (ZIE ELEKTRISCHE AANSLUITING).

Sunshower B.V.
Hoogoorddreef 63-65
1101 BB Amsterdam
Nederland

T +31 (0)20 462 14 60
www.sunshower.eu
info@sunshower.nl

CONFORMITEITSVERKLARING

Sunshower B.V., Hoogoorddreef 63-65, 1101 BB Amsterdam (Nederland) verklaart hierbij op eigen verantwoordelijkheid, dat deze Sunshower DELUXE is gefabriceerd volgens de voorschriften in de volgende richtlijnen:

- Laagspanningsrichtlijn 2014/35/EU
- Richtlijn 2014/30/EU voor elektromagnetische compatibiliteit van het Europees Parlement

Normen gebruikt om de conformiteit te ondersteunen:

- EN60335-1:2012 + A11:2014 + AC2014 + A13:2017 + A1:2019 + A2:2019 + A14:2019
- EN60335-2-27:2014 + A1:2020 + A2:2020
- EN61000-6-3:2007 + A1:2011 + AC:2012
- EN61000-6-1:2007
- EN61000-6-1:2019
- EN61000-3-3:2013
- EN61000-3-2:2014

Dit Sunshower product is IPX5 gekeurd en speciaal ontwikkeld voor gebruik en installatie in de douche (zone 1).

Nederland, Amsterdam, 1 jan 2020

Ondertekend voor en namens:



M. Wegdam, Technisch Directeur



Sunshower B.V.
Hoogoorddreef 63-65
1101 BB Amsterdam
Nederland

T +31 (0)20 462 14 60
www.sunshower.eu
info@sunshower.nl

VOORBEREIDING

ONDERDELEN DOOS

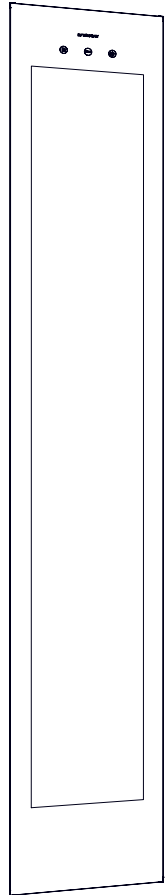

GLASPLAAT

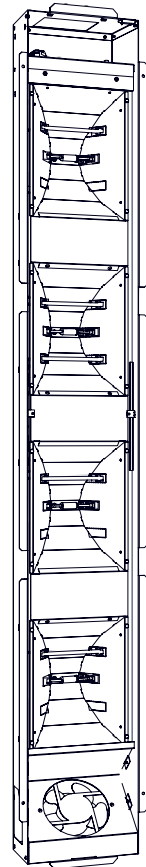

BINNENWERK

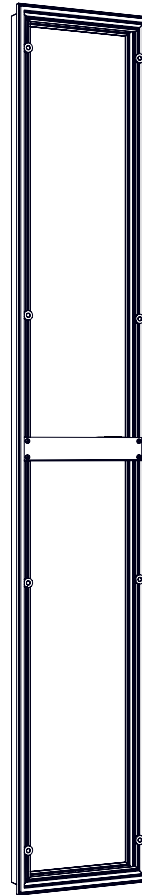

WANDFRAME

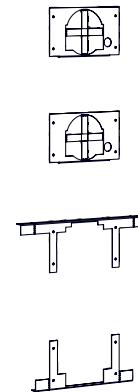

SCHETSPLATEN +
AANSLUITMOFFEN

IN DE DOOS

- Installatiezakje
- 2x Schetsplaten
- 2x Aansluitmoffen
- 2x Brillen

NIET MEEGELEVERD

- Kitspuit
- Rolmaat
- Schroevendraaier (+)
- Waterpas
- 2x Schroeven
- 2x Ventilatiekanalen (rond/
rechthoekig), max. 3 m
- 8x Kanaalbeugels
- 2x Ventilatioorosters
- 2x (Terugslagkleppen)

VOORBEREIDING

BEMATING

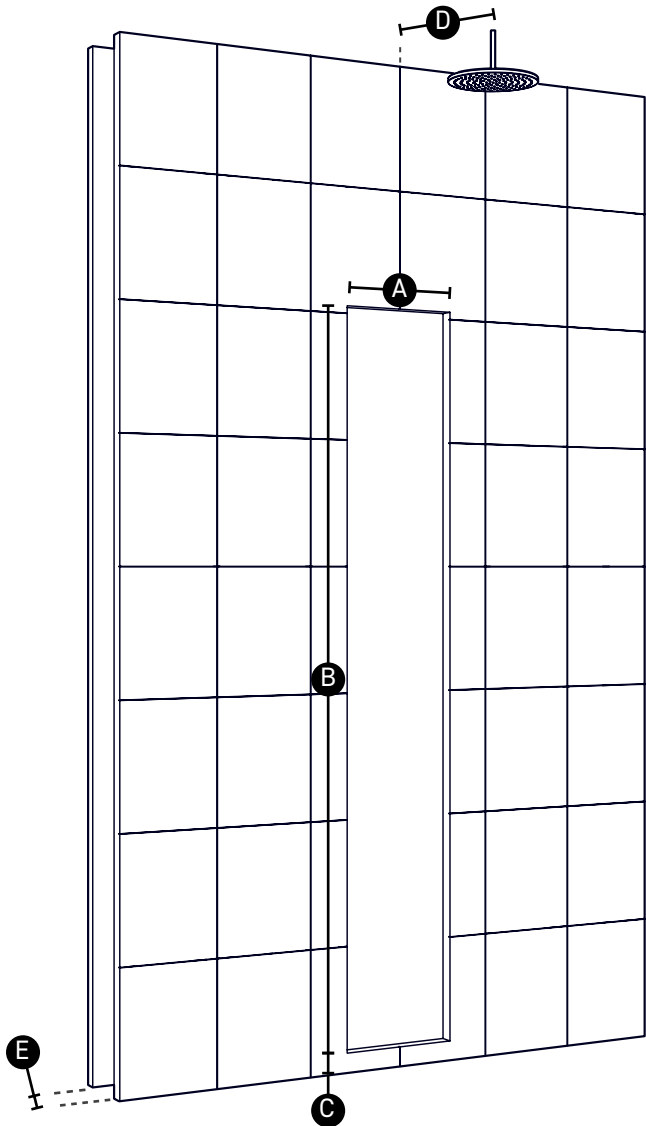

INSTRUCTIES

Construeer de uitsparing in de muur volgens de getoonde afmetingen.

BENODIGDHEDEN

- Rolmaat
- Waterpas

A	300 MM
B	1850 MM
C	100 MM
D	450 MM
E	MIN 165 MM ZIE P22 / P23

VOORBEREIDING

ELEKTRICITEIT

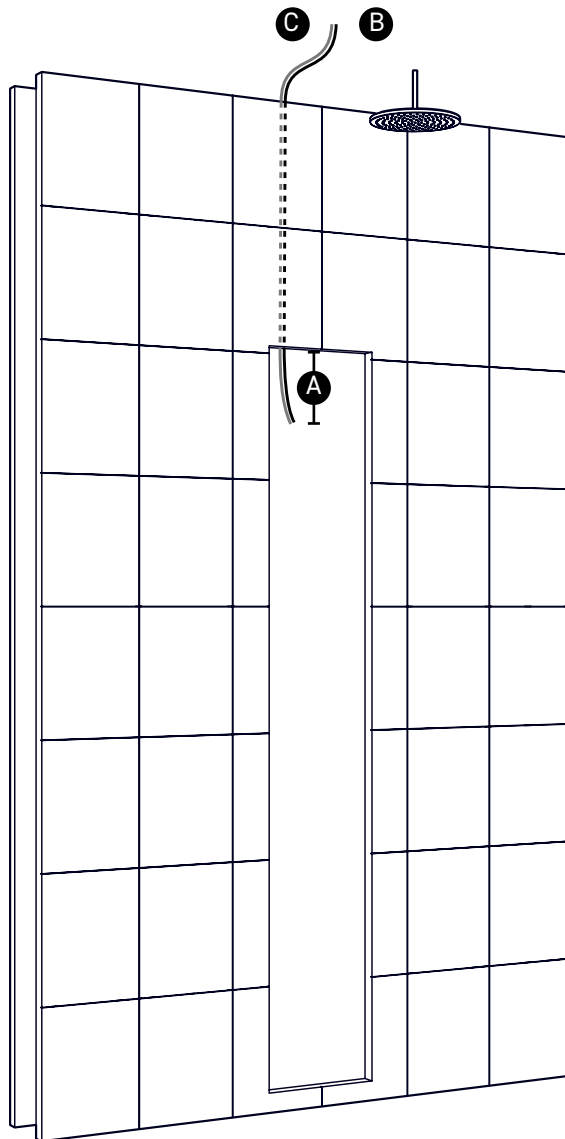

INSTRUCTIES

Zorg voor een YmV-kabel van minimaal 2,5mm² en een potentieelvereffeningskabel van 6mm² zonder PVC-buis of 2,5mm² met PVC-buis. De Sunshower moet worden aangesloten op een eigen 230V~ 50Hz groep voorzien van een aardlekschakelaar (30mA) met een 16A zekering.



ALLE ELEKTRISCHE WERKZAAMHEDEN MOETEN WORDEN UITGEVOERD DOOR EEN ERKEND ELEKTRICIEN IN OVEREENSTEMMING MET DE GELDENDE RICHTLIJNEN (HD 60364-7-701 E.D.) EN DE NATIONALE VOORSCHRIFTEN (BV. VOOR NEDERLAND NEN 1010 - 701). ER MOET EEN APARTE STROOMAANSLUITING MET APARTE ZEKERING EN APARTE AARDLEKSCHAKELAAR WORDEN VOORZIEN.

- A** 500 MM
- B** VOEDING 3-ADERIG
- C** POTENTIAAL-VEREFFENINGSKABEL

VOORBEREIDING

VENTILATIE

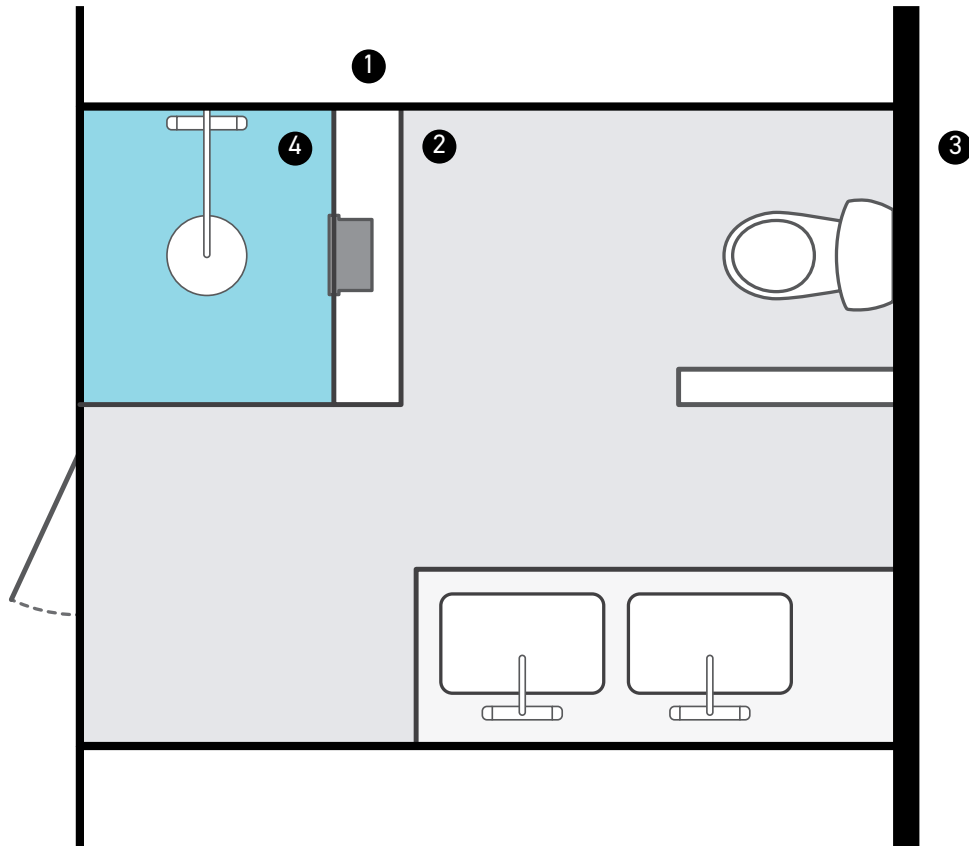

- 1 DROGE RUIMTE
- 2 BADKAMER
- 3 BUITEN
- 4 DOUCHERUIMTE

- A PAGINA 22 VOORKEUR
- B PAGINA 23
- B PAGINA 23
- NIET MOGELIJK

INSTRUCTIES

ALGEMENE RICHTLIJNEN

VENTILATIE:

- Alle inbouwapparaten van Sunshower dienen geïnstalleerd te worden met ventilatiekanalen
- Ventilatie toe- en afvoer mogen beide maximaal 3 m bedragen
- De ruimte waaruit/waarnaar geventileerd wordt moet minimaal 12m³ zijn
- De kanalen kunnen van elk materiaal zijn, met afmetingen Ø100 mm of 110*55 mm
- Leg zo min mogelijk bochten aan in de kanalen
- De Sunshower mag niet aangesloten worden op een bestaand ventilatiesysteem

TERUGSLAGKLEPPEN:

Het installeren van terugslagkleppen is verplicht wanneer de lucht voor uw Sunshower uit een vochtige ruimte gehaald wordt, bijvoorbeeld van buiten of uit de badkamer. Zie de weergegeven afbeelding en volgende pagina's voor instructies. De terugslagkleppen zijn (als set met glasplaatjes) bij te bestellen of los verkrijgbaar bij uw bouwmarkt.

Voorbeelden vochtige ruimten: badkamer, buiten.

Voorbeelden droge ruimten: slaapkamer, gang, wc.

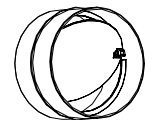
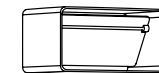

TERUGSLAG-KLEP RECHTHOEK TERUGSLAG-KLEP ROND

INSTALLATIE

A DROGE RUIMTE

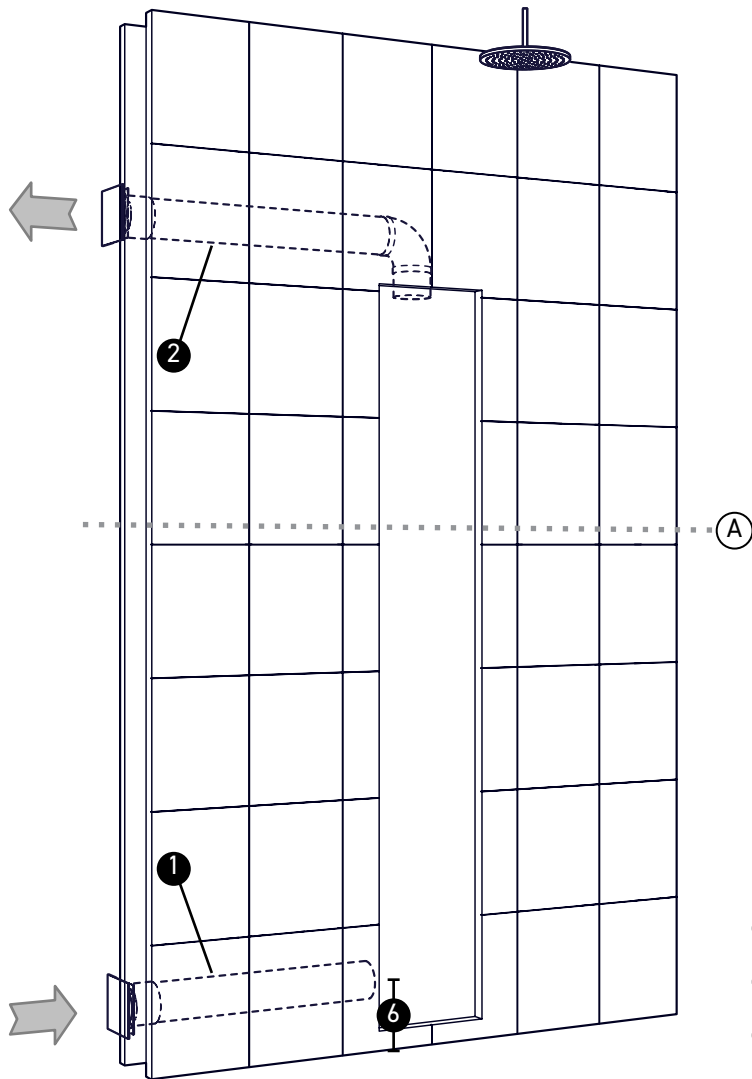

- 1 Aanvoer
- 2 Afvoer
- 3 Achterwand
- 4 Optionele isolatie
- 5 Wand constructie (Gipsplaat/Tegels/Holle wand)

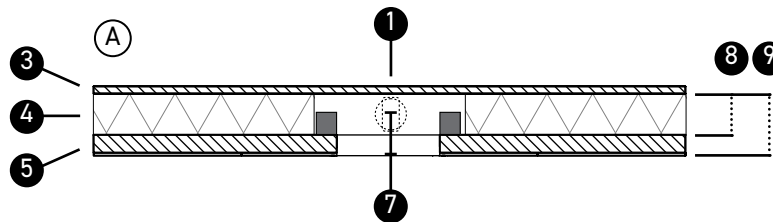

INSTRUCTIES

Leg ventilatiekanalen aan van minimaal $\varnothing 100$ mm of 110x54 mm met een maximale lengte van 3 m (zowel aan- als afvoer). De ventilatieruimte toevoer dient minimaal 12 m³ te zijn.

Terugslagkleppen zijn in dit geval niet verplicht.

BENODIGDHEDEN

- 2x □ Ventilatiekanalen
- 8x □ Kanaalbeugels
- 1x □ Ventilatioosterset (los verkrijgbaar)
- 2x Ventilatioosters

Minimale binnenmaat (8)
ronde kanalen: 110 mm
Minimale binnenmaat (8)
rechthoekige kanalen: 70 mm

- 6 210 MM
- 7 100 MM
- 8 70 MM MIN.
- 9 170 MM MIN.

INSTALLATIE

B VOCHTIGE RUIMTE

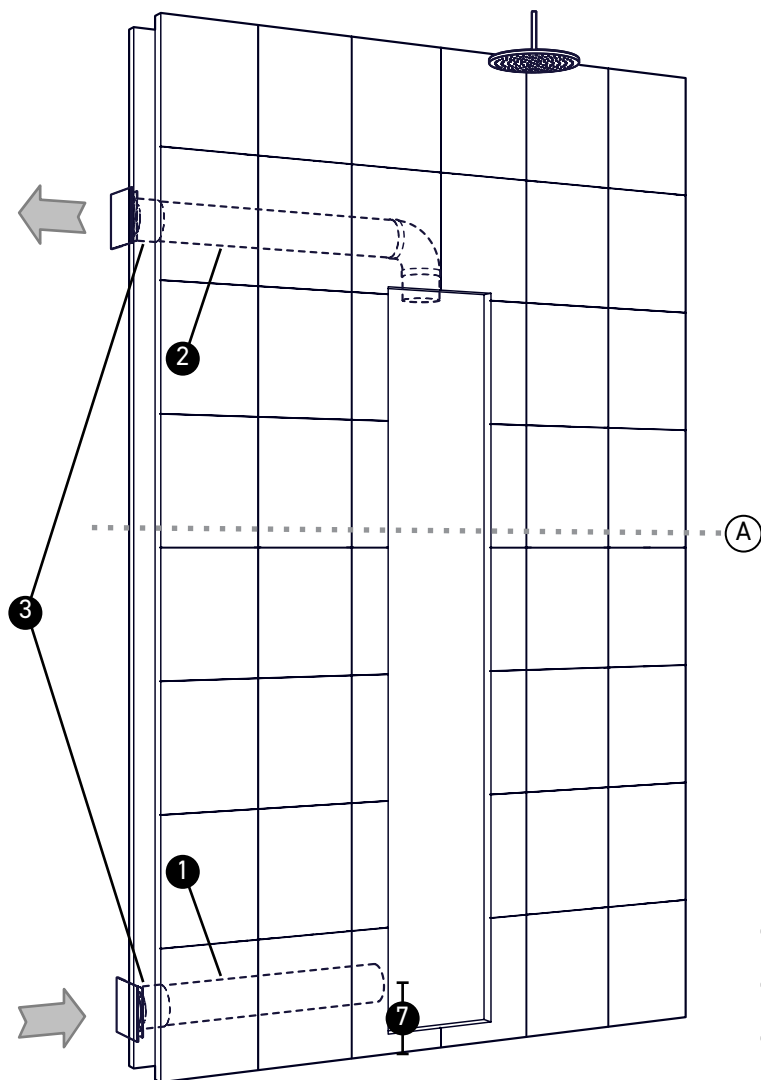

- 1 Aanvoer
- 2 Afvoer
- 3 Terugslagkleppen
- 4 Achterwand
- 5 Optionele isolatie
- 6 Wand constructie (Gipsplaat/Tegels/Holle wand)

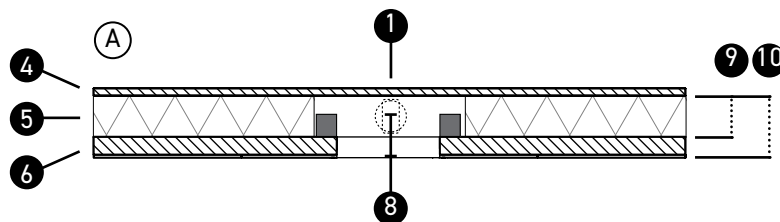

INSTRUCTIES

Leg ventilatiekanalen aan van minimaal $\varnothing 100$ mm of 110×54 mm met een maximale lengte van 3 m (zowel aan- als afvoer). De ventilatieruimte toevoer dient minimaal 12 m^3 te zijn.

Terugslagkleppen zijn in dit geval wel verplicht.

BENODIGDHEDEN

- 2x Ventilatiekanalen
- 8x Kanaalbeugels
- 1x Ventilatieroosterset (los verkrijgbaar)
- 2x Ventilatieroosters
- 2x Terugslagkleppen

Minimale binnenmaat (9)
ronde kanalen: 110 mm
Minimale binnenmaat (9)
rechthoekige kanalen: 70 mm

- 7 210 MM
- 8 100 MM
- 9 70 MM MIN.
- 10 170 MM MIN.

INSTALLATIE

INSTALLATIE FRAME

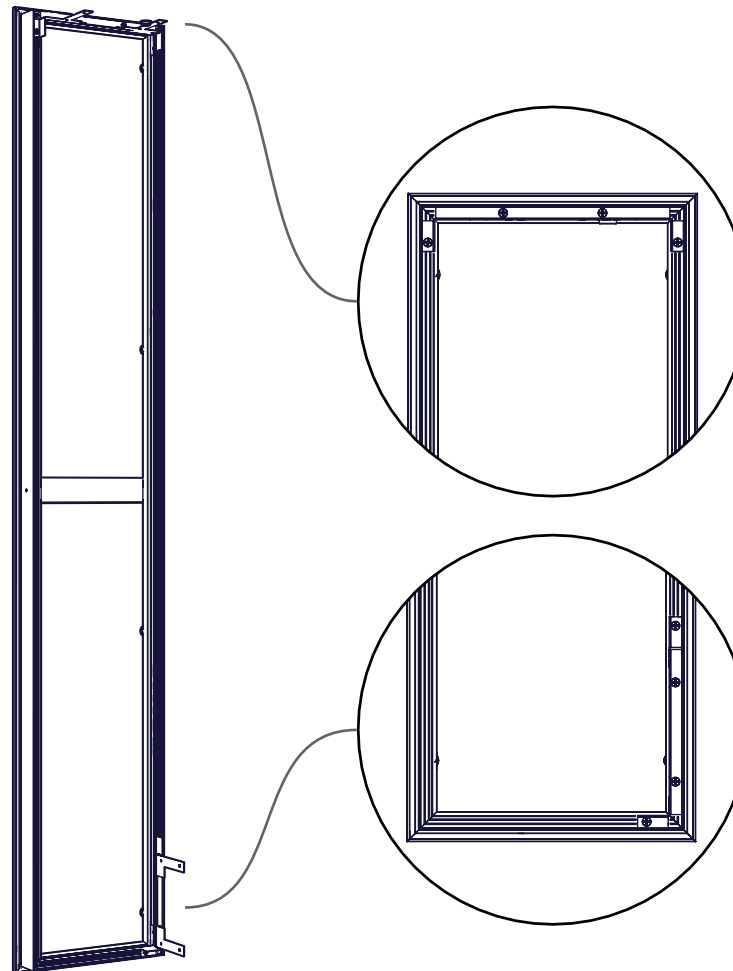
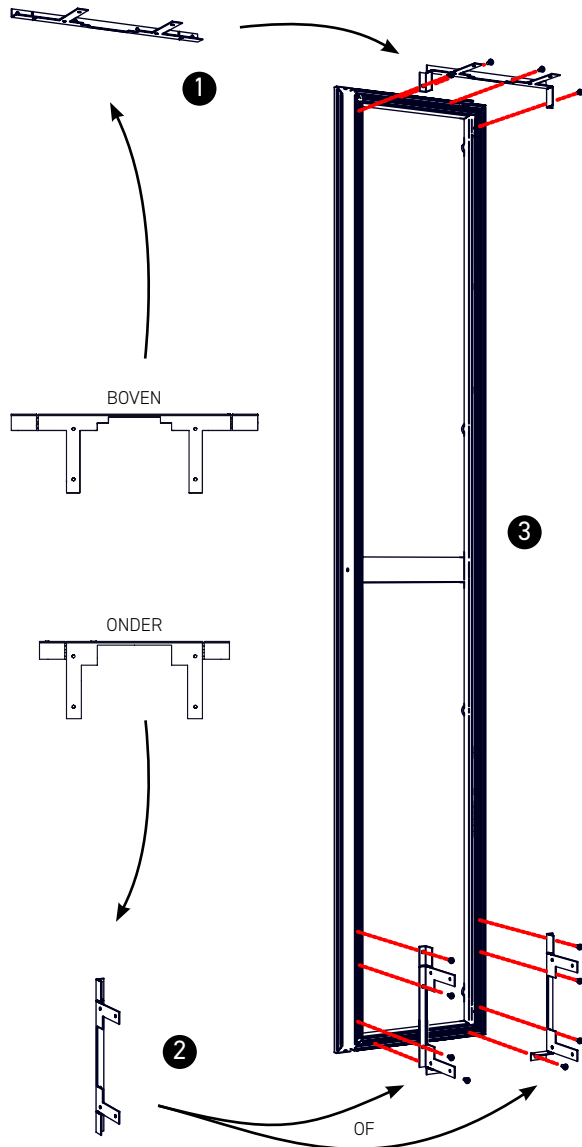

INSTRUCTIES

- 1 Vouw de bovenste schetsplaat zoals aangegeven
- 2 Vouw de onderste schetsplaat zoals aangegeven, afhankelijk van de zijde waar de ventilatietoevoer gaat komen
- 3 Monteer beide schetsplaten aan de onder- en bovenkant van het frame zoals aangegeven met bijgeleverde schroeven

BENODIGDHEDEN

- Schroevendraaier (+)
- 2x Schetsplaten
- 8x Schroeven

INSTALLATIE

INSTALLATIE FRAME

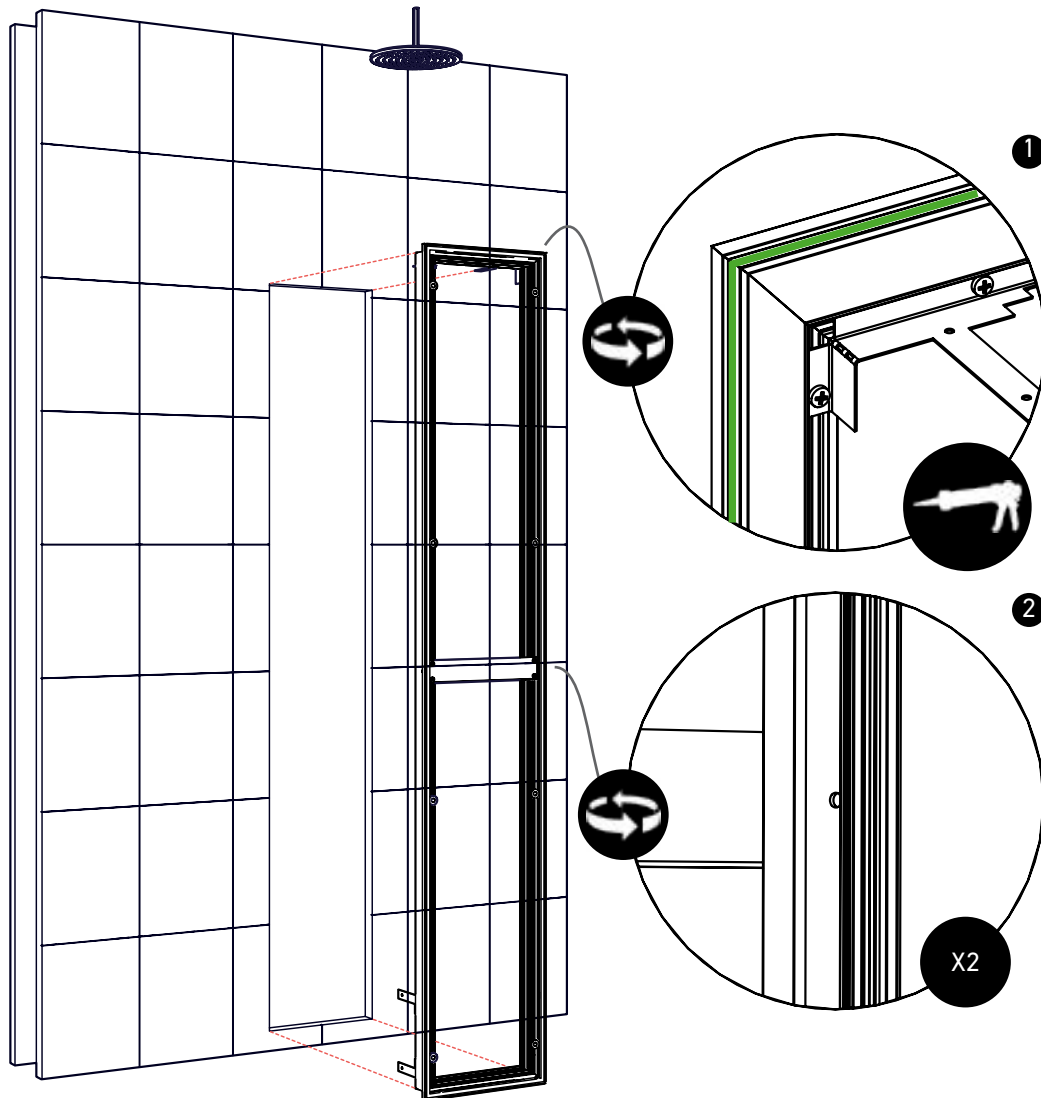

INSTRUCTIES

Werk de wand volledig af voordat het frame geplaatst wordt, op deze manier bereikt u het mooiste resultaat. Installeer vervolgens het frame:

- 1 Breng rondom kit aan op de achterzijde van het wandframe
- 2 Schroef het frame vast in de (voorzet)muur aan beide zijkanten

BENODIGDHEDEN

- Kitspuit
- Schroevendraaier (+)
- 2x □ Schroeven



LET OP:

Deze instructies zijn kritiek voor het garanderen van de IPX5 afdichting

INSTALLATIE

INSTALLATIE FRAME

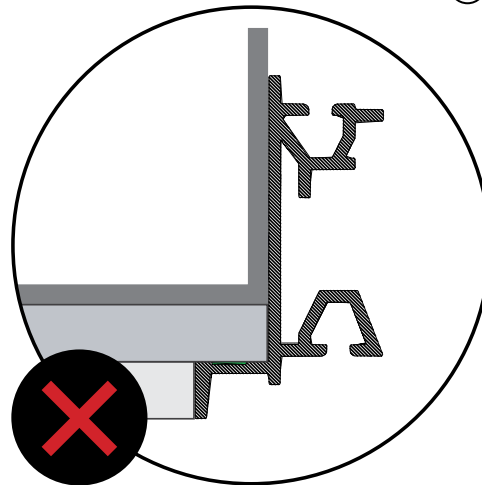
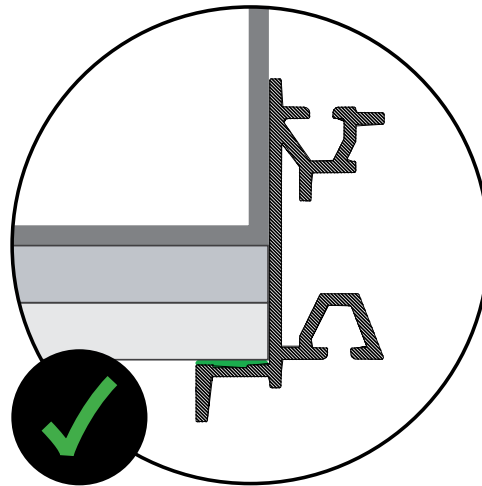
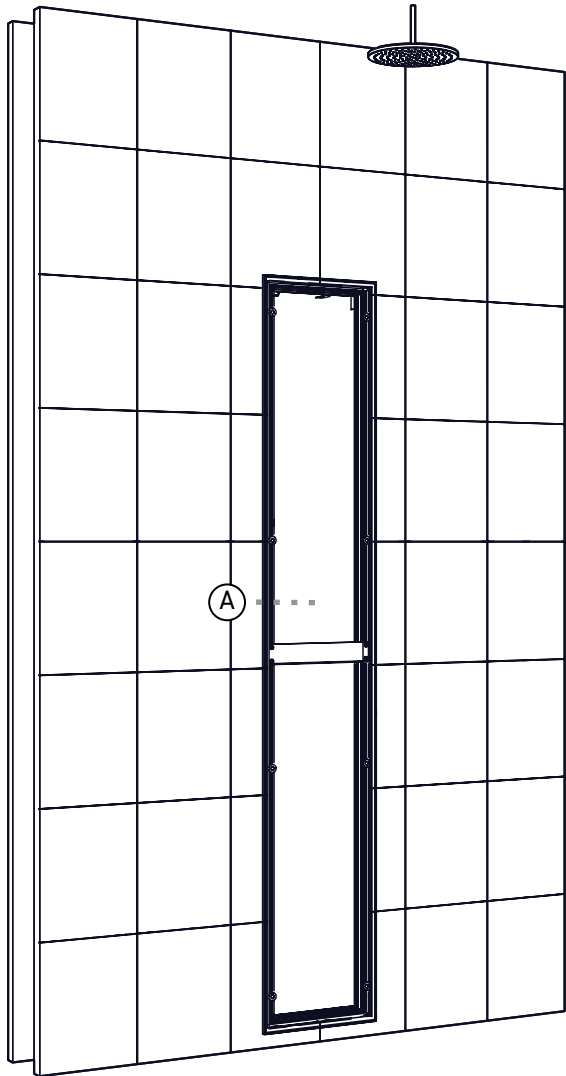

Let erop dat het frame op de muur gemonteerd wordt, in plaats van gelijk met de muur. Dit om de waterdichtheid van de Sunshower te garanderen.

INSTALLATIE

INSTALLATIE FRAME

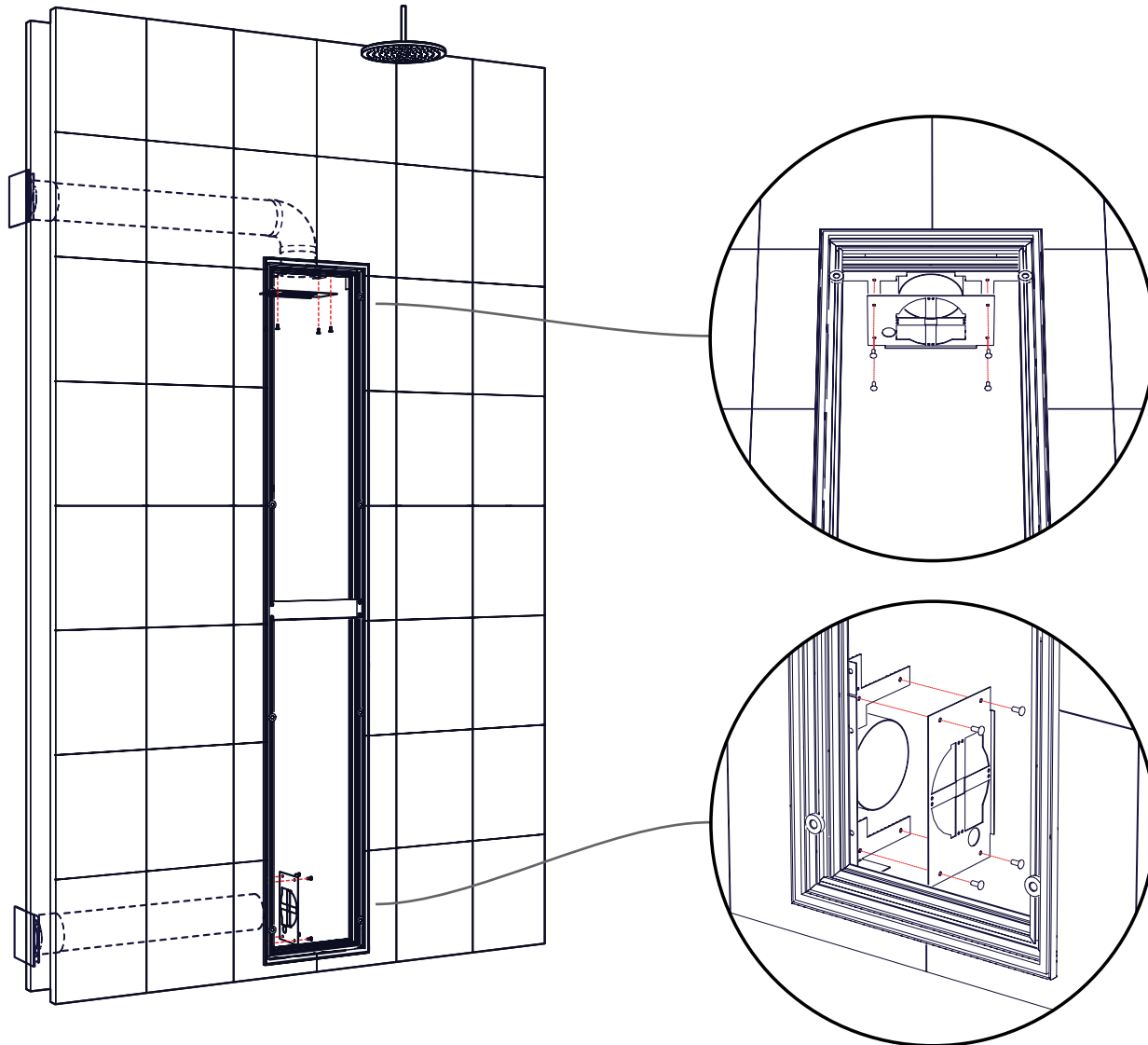

INSTRUCTIES

Sluit de aansluitmoffen aan op de schetsplaten met behulp van de druknagels. Vouw de lippen van de aansluitmoffen om en schuif de aansluitmoffen in de ventilatiekanalen.

Deel 1 van de installatie is klaar. Laat de kit 24 uur drogen alvorens met deel 2 te beginnen.

BENODIGDHEDEN

- 2x □ Aansluitmoffen
- 8x □ Nylon druknagels



DELUXE
WHITE / BLACK / ORGANIC GREY

INSTALLATIONSHANDBUCH

TEIL **1** - VORBEREITUNG

ALLGEMEINE ANWEISUNGEN



ALLGEMEIN

DIESE PLANUNGSANWEISUNG UNBEDINGT VOR DER MONTAGE SORGFÄLTIG LESEN. MONTAGE NUR DURCH AUSGEBILDETES FACHPERSONAL. DER ELEKTRISCHE ANSCHLUSS VON SUNSHOWER KOMPONENTEN DARF NUR DURCH EINEN KONZESSIONIERTEN ELEKTRIKER ERFOLGEN. FÜR SCHÄDEN DURCH NICHT FACHGERECHTE MONTAGE HAFTET SUNSHOWER NICHT.



ELEKTRIZITÄT

DER ELEKTRISCHE ANSCHLUSS VON SUNSHOWER KOMPONENTEN DARF NUR DURCH EINEN KONZESSIONIERTEN ELEKTRIKER ERFOLGEN. DIE MONTAGE UND DER ELEKTRISCHE ANSCHLUSS DER SUNSHOWER INSTALLATION MUSS ENTSPRECHEND DEN FÜR DEN AUFSTELLORT GELTENDEN INTERNATIONALEN UND NATIONALEN NORMEN UND RICHLINIEN, WIE Z.B. DIN VDE 0100, ERFOLGEN. DER SUNSHOWER MUSS ÜBER EINEN SEPARATEN, BAUSEITIG VORZUSEHENDEN FEHLERSTROMSCHUTZSCHALTER (RCD) ABGESICHERT WERDEN (SIEHE ELEKTROANSCHLUSS).

Sunshower B.V.
Hoogoorddreef 63-65
1101 BB Amsterdam
Niederlande

T +31 (0)20 462 14 60
www.sunshower.eu
info@sunshower.nl

KONFORMITÄTSBESCHEINIGUNG

Sunshower B.V., Hoogoorddreef 63-65, 1101 BB Amsterdam (Niederlande) erklärt hiermit eigenverantwortlich, dass das Produkt Sunshower DELUXE hergestellt ist gemäß den Bestimmungen der Richtlinien:

- Richtlinie 2014/30/EU der Europäischen Gemeinschaft
- Niederspannungsrichtlinie 2014/35/EU der Europäischen Gemeinschaft

Und gemäß den folgenden Standards:

- EN60335-1:2012 + A11:2014 + AC2014 + A13:2017 + A1:2019 + A2:2019 + A14:2019
- EN60335-2-27:2014 + A1:2020 + A2:2020
- EN61000-6-3:2007 + A1:2011 + AC:2012
- EN61000-6-1:2007
- EN61000-6-1:2019
- EN61000-3-3:2013
- EN61000-3-2:2014

Dieses Sunshower-Produkt ist IPX5-zertifiziert und wurde speziell für die Verwendung und Installation in der Dusche (Zone 1) entwickelt.

Niederlande, Amsterdam, 1 jan 2020

Unterzeichnet für und im Namen von:



M. Wegdam, Technischer Direktor



Sunshower B.V.
Hoogoorddreef 63-65
1101 BB Amsterdam
Niederlande

T +31 (0)20 462 14 60
www.sunshower.eu
info@sunshower.nl

VORBEREITUNG

DOSENTEILE

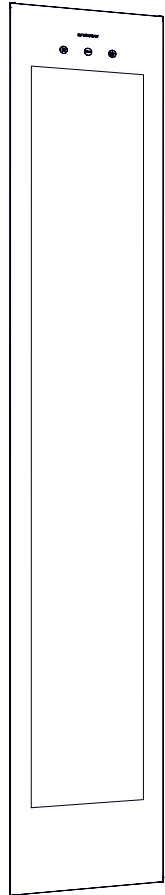

GLASPLATTE

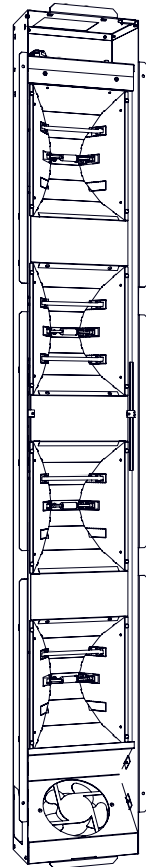

INNENARBEITEN

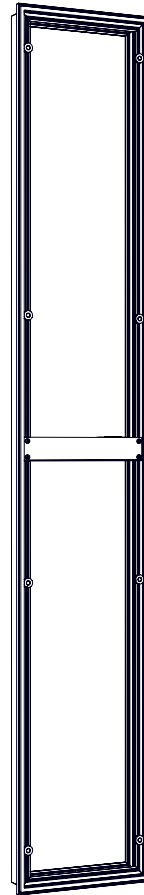

WANDRAHMEN

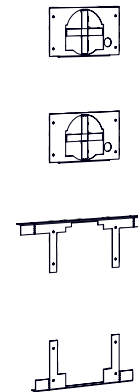

ECKBLECHE +
ANSCHLUSSMUFFEN

IN DER DOSE

- Installationsbeutel
- 2x Eckbleche
- 2x Anschlussmuffen
- 2x Brillen

NICHT IM LIEFERUMFANG ENTHALTEN

- MS Polymer
- Maßband
- Schraubendreher (+)
- Wasserwaage
- 2x Schrauben
- 2x Lüftungskanäle (rund/
rechteckig), max. 3 m
- 8x Kanalhalterungen
- 2x Lüftungsgitter
- 2x (Rückschlagventile)

VORBEREITUNG

DIMENSION

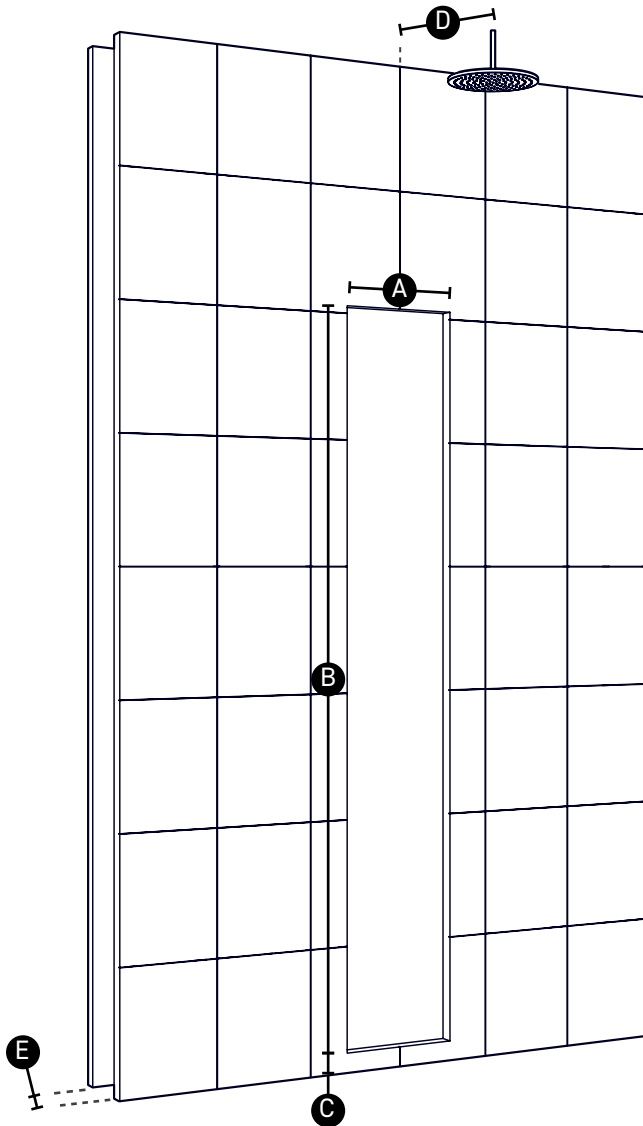

ANWEISUNGEN

Konstruieren Sie die Aussparung in der Wand entsprechend den angegebenen Abmessungen.

ARBEITSMATERIALIEN

- Maßband
- Wasserwaage

A	300 MM
B	1850 MM
C	100 MM
D	450 MM
E	MIN 165 MM <small>SIEHE P35 / P36</small>

VORBEREITUNG

ELEKTRIZITÄT

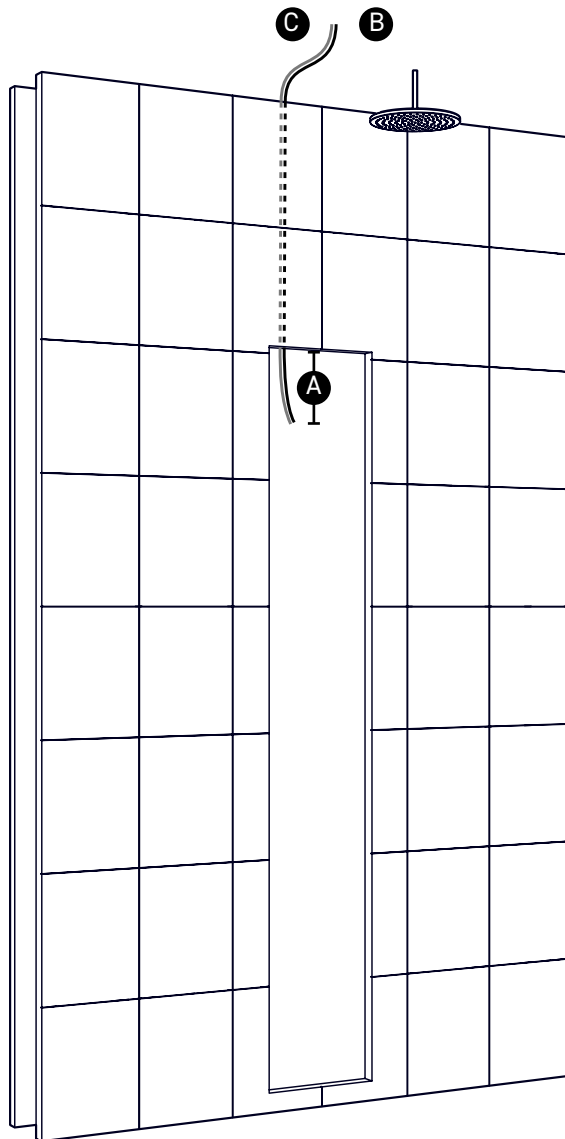

ANWEISUNGEN

Sie benötigen ein NYM-J Kabel 3x2,5mm² und ein Potentialausgleichskabel von 6mm² ohne PVC-Schlauch oder 2,5mm² mit PVC-Schlauch. Die Sunshower wird mit einem FI-Schalter, von 230V~ 50Hz und einer 16A Sicherung an eine eigene Gruppe angeschlossen.



SÄMTLICHE ELEKTROARBEITEN SIND DURCH EINE KOZESSIONIERTE ELEKTRO-FACHKRAFT GEMÄSS DEN GELTENDEN DIN EN-VORGABEN (DIN VDE 0100 701 ETC) DEN LÄNDERSPEZIFISCHEN VORSCHRIFTEN UND DEN ÖRTLICHEN EVU-VORSCHRIFTEN AUSZUFÜHREN. ES MUSS EIN SEPARATER STROMANSCHLUSS MIT SEPERATOR ABSICHERUNG UND SEPARATEM FEHLERSTROMSCHUTZSCHALTER GELEGT WERDEN.

- A** 500 MM
- B** NETZTEIL 3-ADRIG
- C** POTENTIAL-AUSGLEICHSKABEL

VORBEREITUNG

BELÜFTUNG

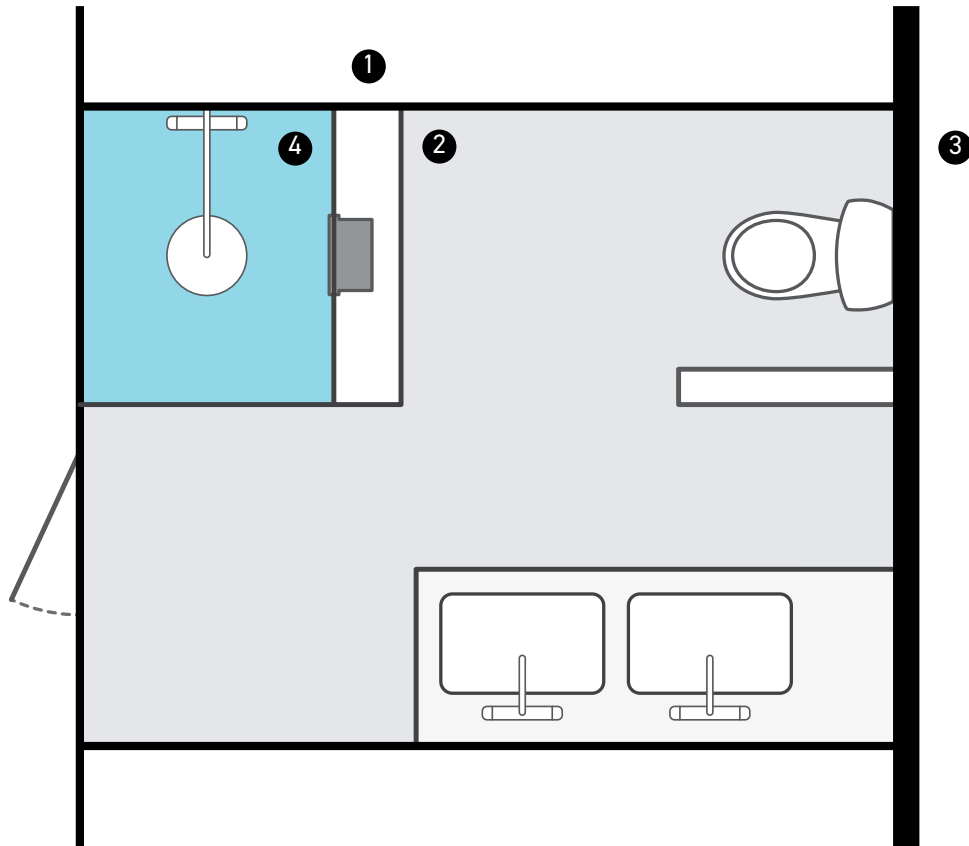

①	TROCKENER RAUM	A	SEITE 35	BEVORZUGT
②	BADEZIMMER	B	SEITE 36	
③	DRAUSSEN	B	SEITE 36	
④	DUSCHKABINE	-	-	NICHT MÖGLICH

ANWEISUNGEN

ALLGEMEINE AUFBAURICHTLINIEN:

- Alle Sunshower-Geräte müssen mit Lüftungskanälen ausgestattet sein
- Die Be- und Entlüftung darf maximal 3 m betragen
- Der Raum, von dem aus / zu dem gelüftet werden soll, muss mindestens 12 m³ betragen
- Die Kanäle können aus jedem Material mit den Abmessungen $\varnothing 100$ mm oder 110 * 55 mm bestehen. Für den runden Lüftungskanal $\varnothing 100$ mm können Sie z.B. ein Alu- Flexrohr verwenden.
- Machen Sie so wenig Biegungen wie möglich in den Kanälen
- Die Sunshower darf nicht an ein vorhandenes Lüftungssystem angeschlossen werden

RÜCKSCHLAGVENTILE:

Der Einbau von Rückschlagventilen ist zwingend erforderlich, wenn die Luft für Ihre Sunshower aus einem feuchten Bereich abgesaugt wird, z.B. von außen oder aus dem Bad. Siehe die Abbildung und die folgenden Seiten für weitere Informationen. Die Rückschlagventile können bestellt (als Set mit Glasscheiben) oder separat in Ihrem Sanitär- Fachgroßhandel erworben werden.

Beispiele für Feuchträume:
Badezimmer, Außenbereich.

Beispiele für trockene Räume:
Schlafzimmer, Flur, WC.

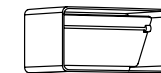

RÜCKSCHLAG-
VENTIL
RECHTECKIG

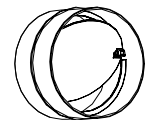

RÜCKSCHLAG-
VENTIL
RUND

INSTALLATION

A TROCKENER RAUM

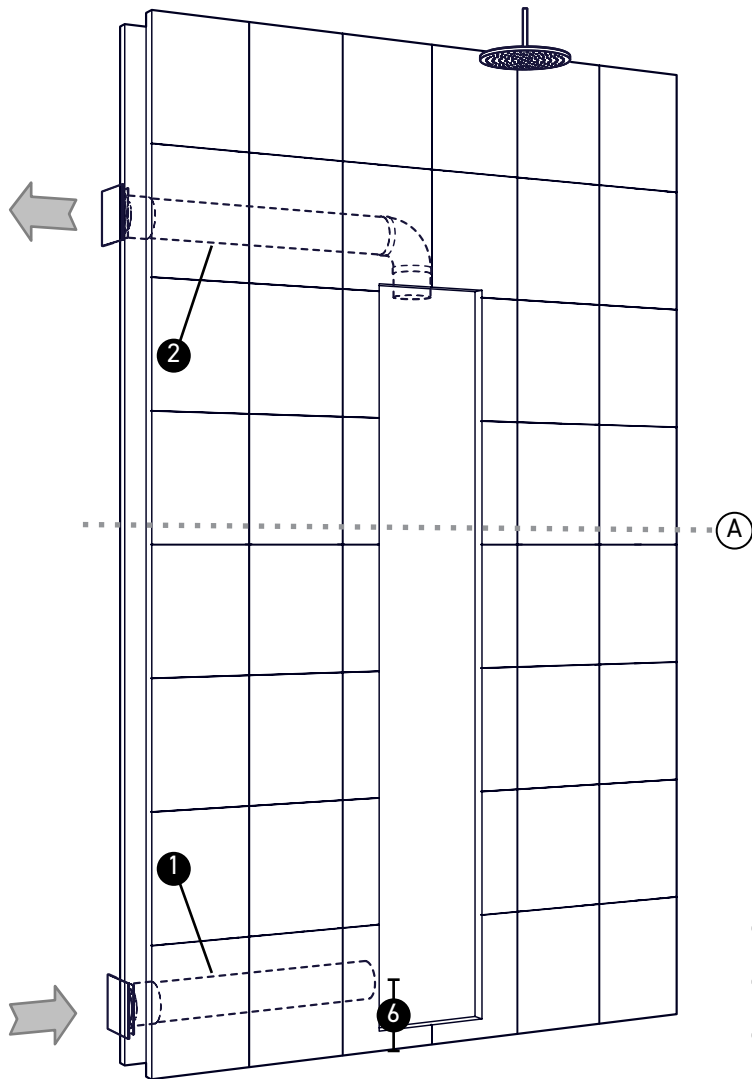

- 1 Zufuhr
- 2 Abfuhr
- 3 Rückwand
- 4 Optionale Isolierung
- 5 Wandaufbau (Trockenbau/Fliesen/Hohlwand)

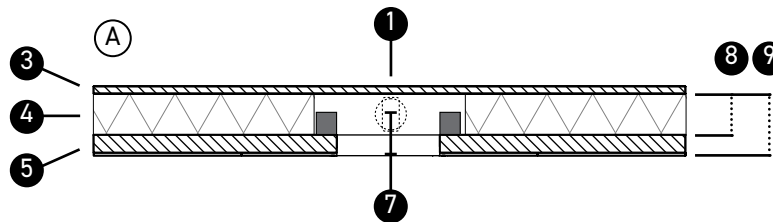

ANWEISUNGEN

Verlegen Sie Lüftungskanäle von mindestens $\varnothing 100$ mm oder 110x54 mm mit einer maximalen Länge von 3 m (sowohl Zu- als auch Abfuhr). Für den runden Lüftungskanal $\varnothing 100$ mm können Sie z.B. ein Alu- Flexrohr verwenden. Die Lüftungsraumzufuhr muss mindestens 12 m³ betragen.

In diesem Fall sind Rückschlagventile nicht erforderlich.

ARBEITSMATERIALIEN

- 2x □ Lüftungskanäle
- 8x □ Kanalhalterungen
- 1x □ Lüftungsgitter-set (separat erhältlich)
- 2x Lüftungsgitter

Minimales Innenmaß (8)
 runde Kanäle: 110 mm
 Minimales Innenmaß (8)
 rechteckige Kanäle: 70 mm

- 6 210 MM
- 7 100 MM
- 8 70 MM MIN.
- 9 170 MM MIN.

INSTALLATION

B FEUCHTER RAUM

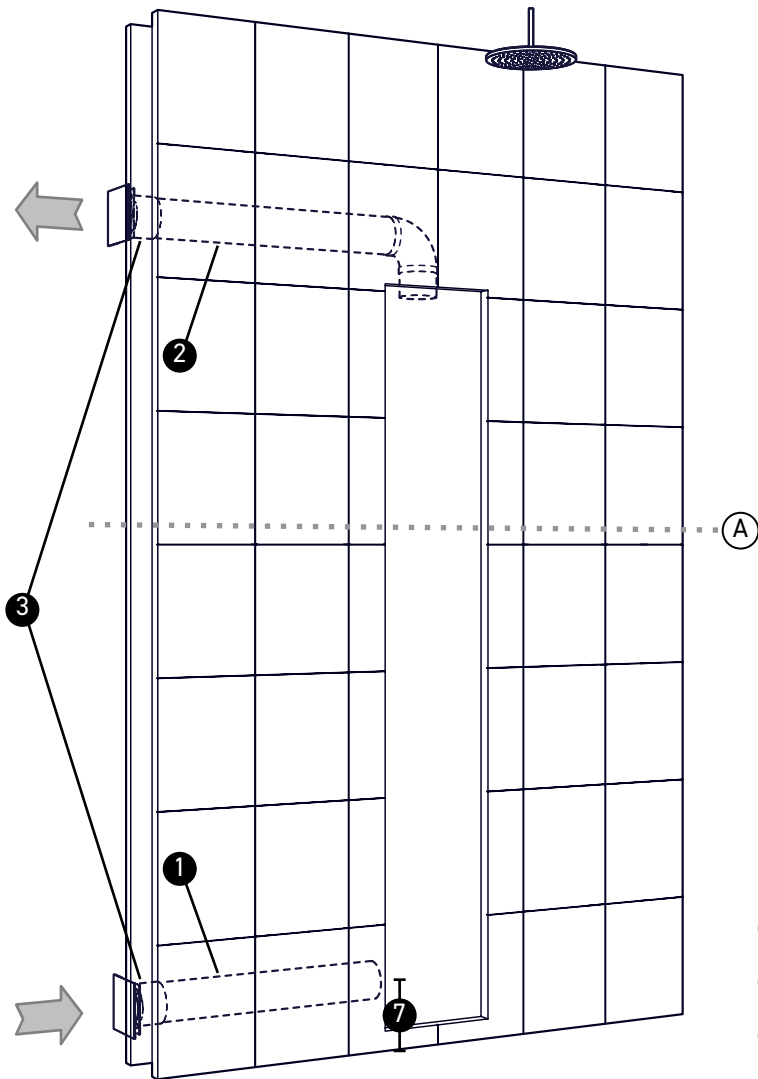

- 1 Zufuhr
- 2 Abfuhr
- 3 Rückschlagventile
- 4 Rückwand
- 5 Optionale Isolierung
- 6 Wandaufbau
(Trockenbau/Fliesen/
Hohlwand)

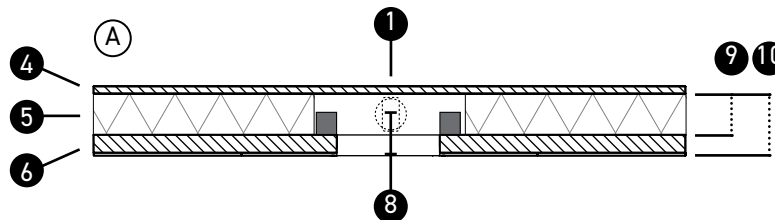

ANWEISUNGEN

Verlegen Sie Lüftungskanäle von mindestens $\varnothing 100$ mm oder 110x54 mm mit einer maximalen Länge von 3 m (sowohl Zu- als auch Abfuhr). Für den runden Lüftungskanal $\varnothing 100$ mm können Sie z.B. ein Alu- Flexrohr verwenden. Die Lüftungsraumzufuhr muss mindestens 12 m³ betragen.

In diesem Fall sind Rückschlagventile zwingend erforderlich.

ARBEITSMATERIALIEN

- 2x □ Lüftungskanäle
- 8x □ Kanalhalterungen
- 1x □ Lüftungsgitter-set (separat erhältlich)
- 2x Lüftungsgitter
- 2x Rückschlagventile

Minimales Innenmaß (9)

 runde Kanäle: 110 mm
 Minimales Innenmaß (9)
 rechteckige Kanäle: 70 mm

- 7 210 MM
- 8 100 MM
- 9 70 MM MIN.
- 10 170 MM MIN.

INSTALLATION

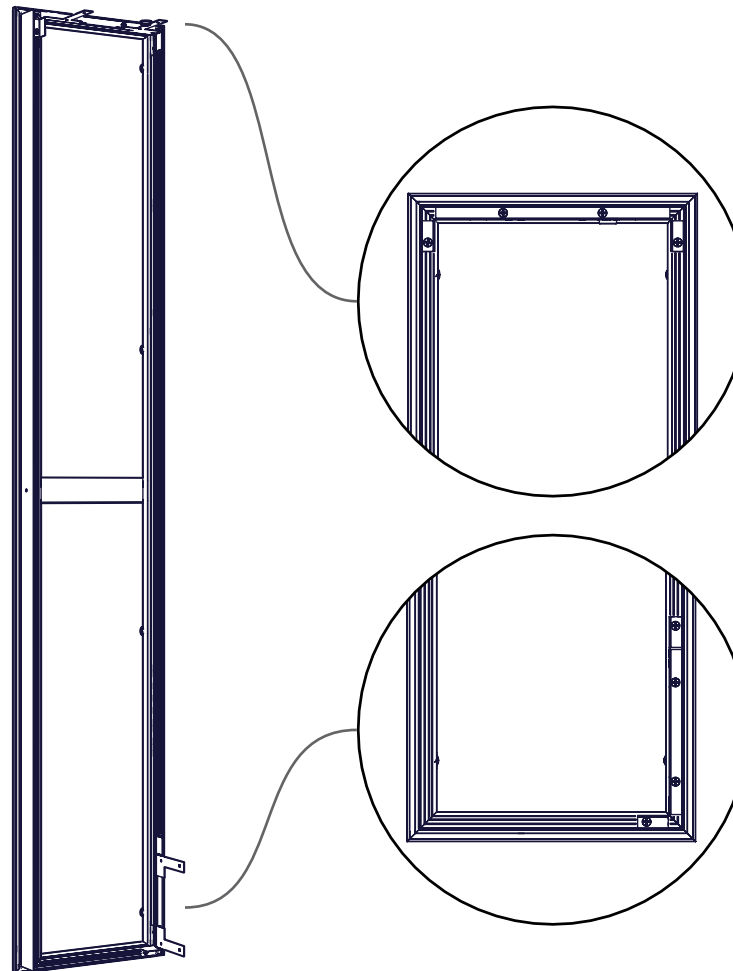
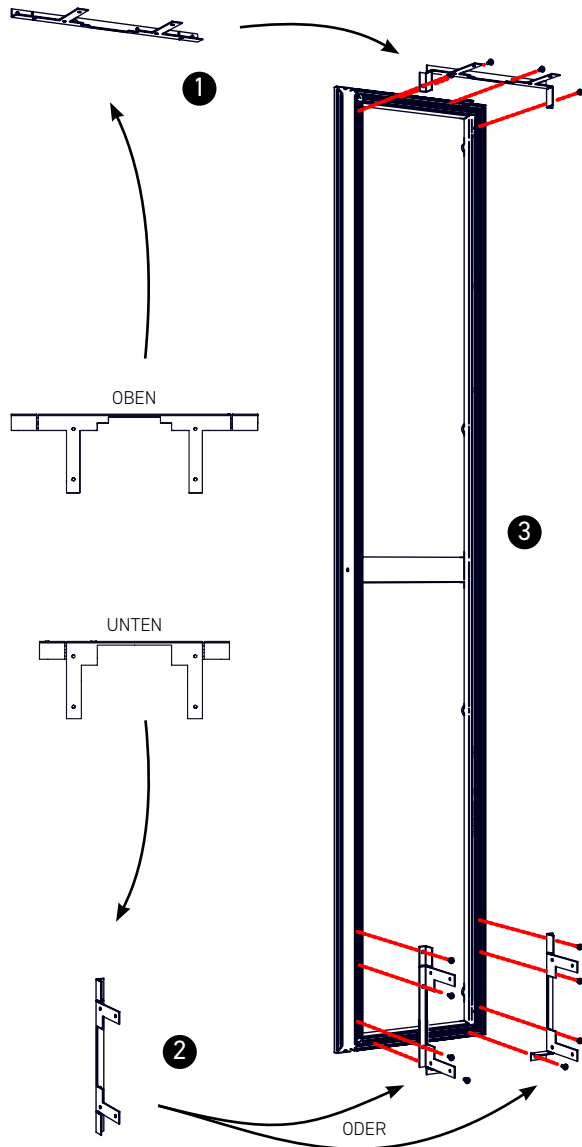
INSTALLATION RAHMEN



ANWEISUNGEN

- 1 Falten Sie das obere Eckblech wie abgebildet
- 2 Falten Sie das untere Eckblech wie abgebildet, je nachdem, auf welcher Seite die Lüftungsversorgung installiert werden soll
- 3 Montieren Sie beide Eckbleche, wie angegeben, mithilfe der mitgelieferten Schrauben oben und unten am Rahmen.

ARBEITSMATERIALIEN

- Schraubendreher (+)
- 2x Eckbleche
- 8x Schrauben

INSTALLATION

INSTALLATION RAHMEN

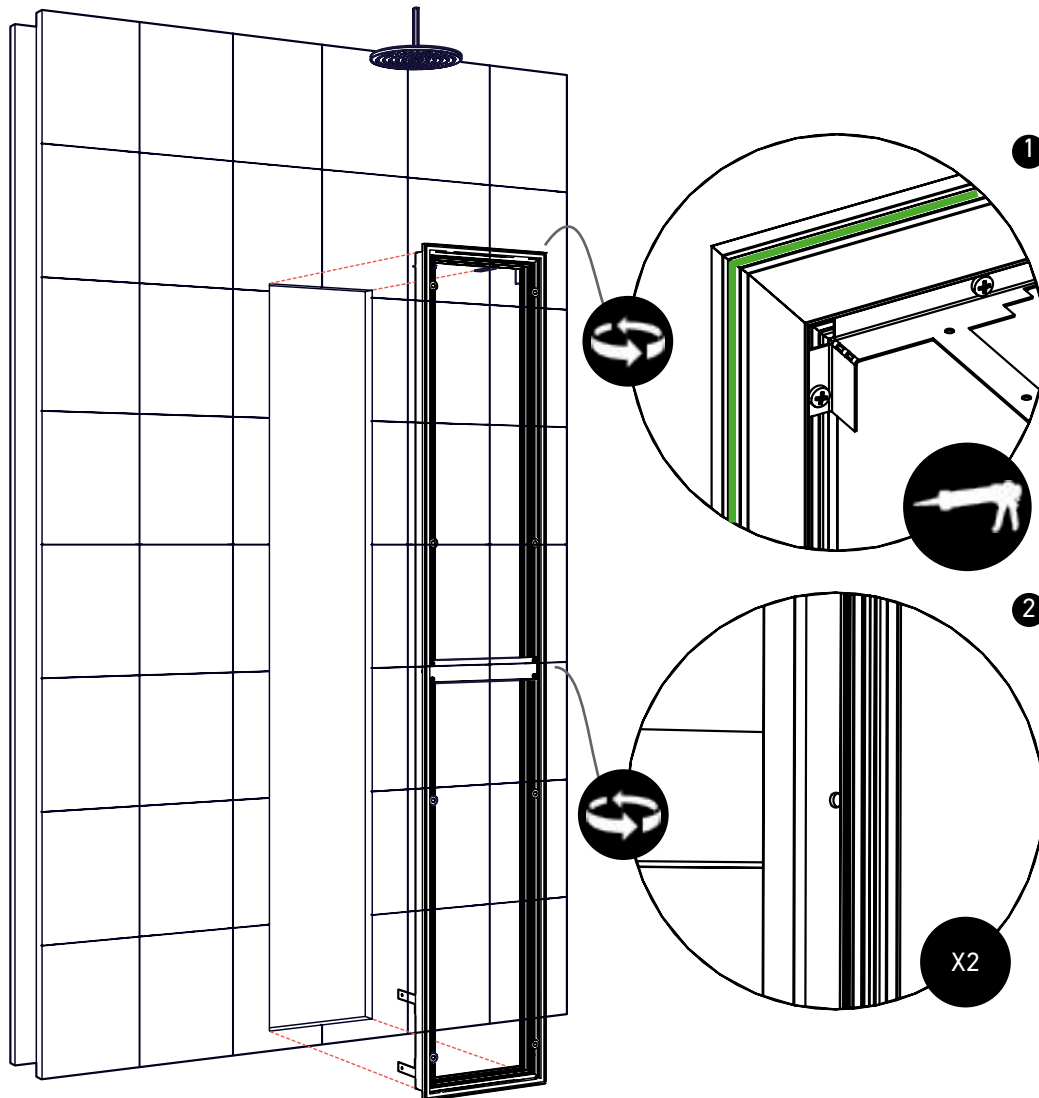

ANWEISUNGEN

Stellen Sie die Wand komplett fertig, bevor Sie den Rahmen platzieren, so erzielen Sie das beste Ergebnis.

Montieren Sie dann den Rahmen:

Tragen Sie auf der Rückseite

- 1 des Wandrahmens eine Rundumversiegelung auf
- Schrauben Sie den Rahmen
- 2 beidseitig in die (Ständer-)Wand

ARBEITSMATERIALIEN

- MS Polymer
- Schraubendreher (+)
- 2x □ Schrauben



ACHTUNG:

Diese Anweisungen sind wichtig, um das IPX5-Siegel zu gewährleisten

INSTALLATION

INSTALLATION RAHMEN

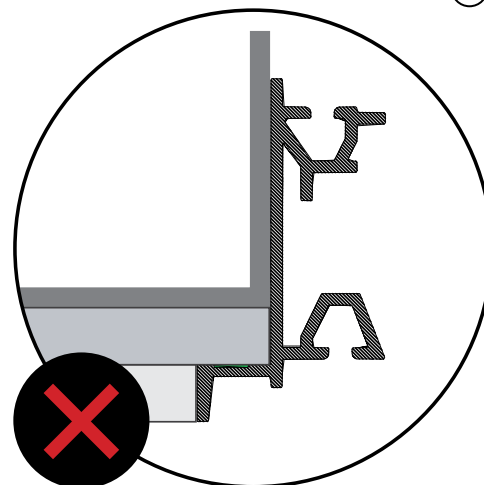
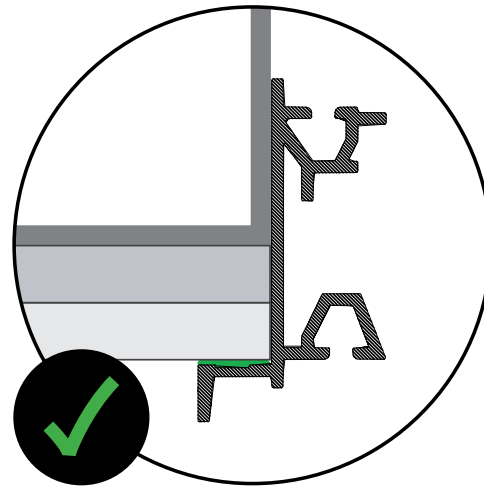
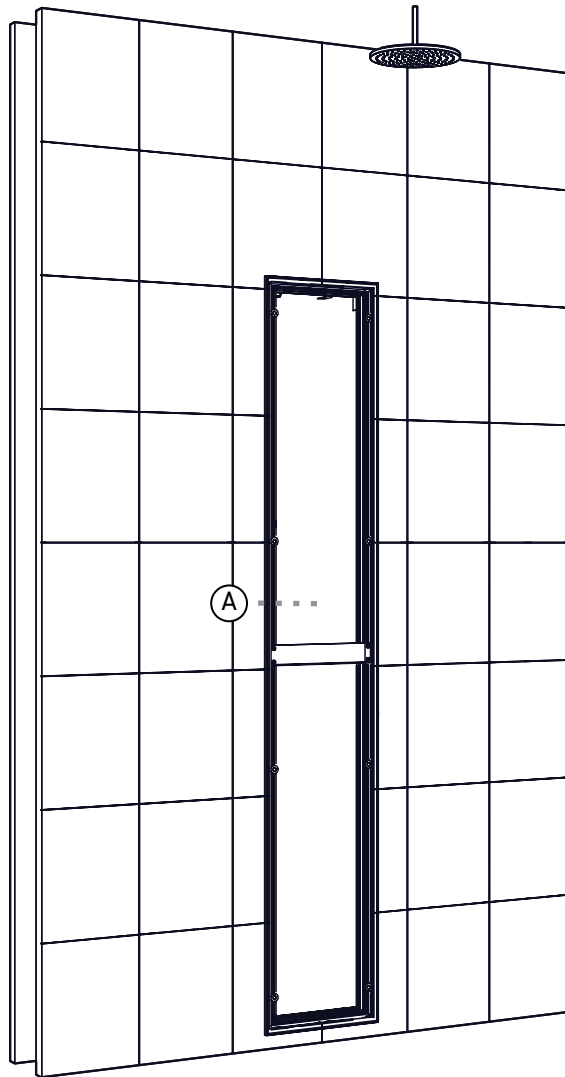

Achten Sie darauf, dass der Rahmen auf der Fliese montiert wird, anstatt bündig mit der Fliese. Dies dient dazu, die Wasserdichtigkeit der Sunshower zu gewährleisten.

INSTALLATION

INSTALLATION RAHMEN

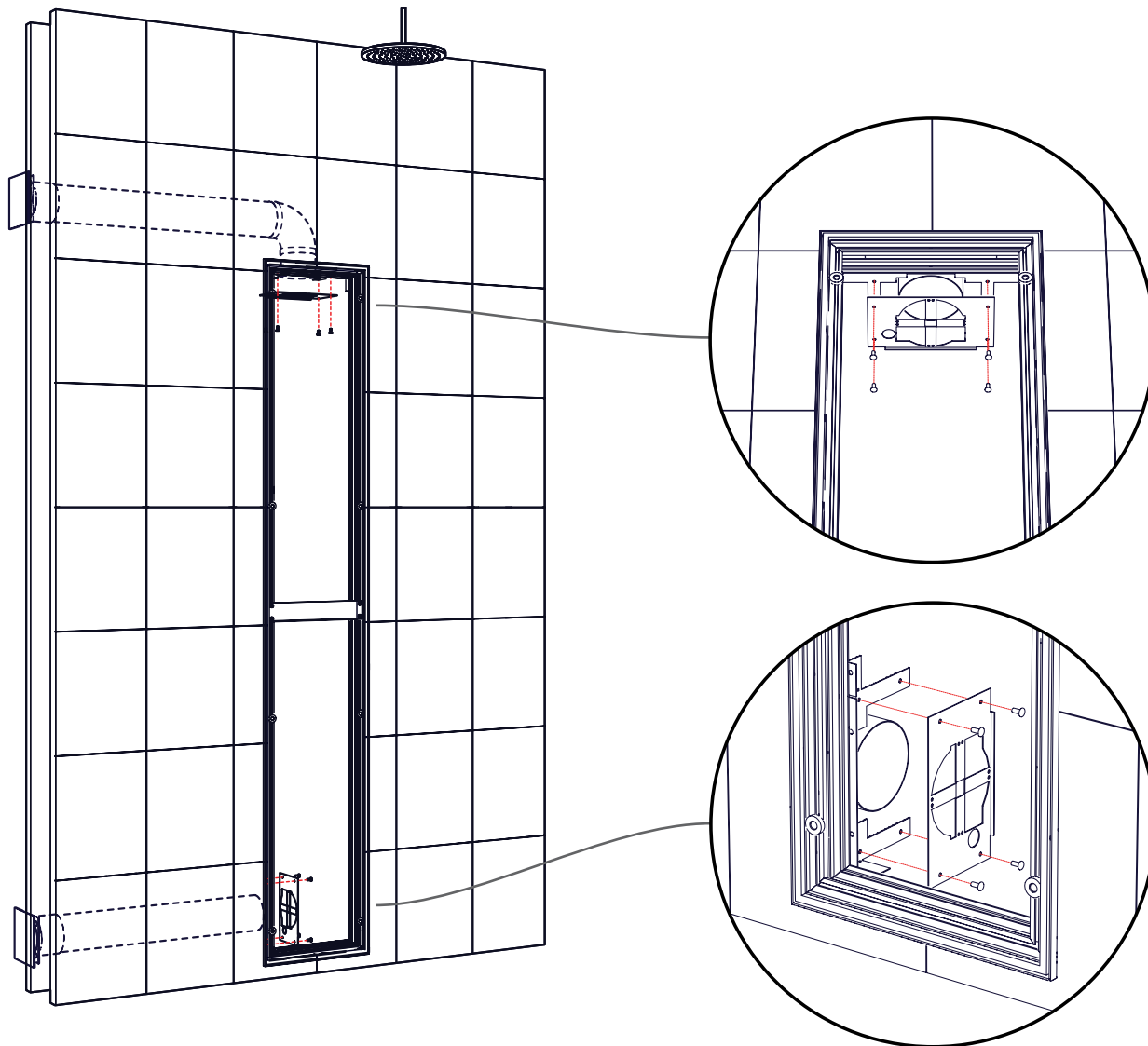

ANWEISUNGEN

Verbinden Sie die Anschlussmuffen mit den Eckblechen mithilfe der Drucknieten. Falten Sie die Lippen der Anschlussmuffen und schieben Sie die Anschlussmuffen in die Lüftungskanäle.

Teil 1 der Installation ist fertig. Lassen Sie die Versiegelung 24 Stunden trocknen, bevor Sie mit Teil 2 beginnen.

ARBEITSMATERIALIEN

- 2x □ Anschlussmuffen
- 8x □ Drucknieten



DELUXE
WHITE / BLACK / ORGANIC GREY

MANUALE DI INSTALLAZIONE

PARTE ❶ - PREPARAZIONE

ISTRUZIONI GENERALI



GENERAL

LEGGERE ATTENTAMENTE QUESTE ISTRUZIONI PRIMA DI PROCEDERE CON L'INSTALLAZIONE. L'INSTALLAZIONE PUÒ ESSERE FATTA SOLO DA UN PROFESSIONISTA QUALIFICATO. EL CONNESSIONI ELETTRONICHE DEL SUNSHOWER DEVONO ESSERE FATTA UN ELETTRICISTA QUALIFICATO. SUNSHOWER NON E' RESPONSABILE DEI DANNI CAUSATI DA UN INSTALLAZIONE NON ERRATA.



ELECTRICITY

LE CONNESSIONI ELETTRICHE DEI COMPONENTI SUNSHOWER DEVONO ESSERE FATTA DA UN PROFESSIONISTA QUALIFICATO. L'INSTALLAZIONE E LA CONNESSIONE DEL SUNSHOWER DEVONE ESSERE FATTA IN ACORDO CON LE REGOLAMENTAZIONI E LE LINEE GUIDA INTERNAZIONALI E NAZIONALI. IL SUNSHOWER DEVE ESSERE PROTETTA DA IMPIANTO DI MESSA A TERRA(VEDI CONNESSIONI ELETTRICHE).

Sunshower B.V.
Hoogoorddreef 63-65
1101 BB Amsterdam
Paesi Bassi

T +31 (0)20 462 14 60
www.sunshower.eu
info@sunshower.nl

DICHIARAZIONE DI CONFORMITÀ

Sunshower B.V., Hoogoorddreef 63-65, 1101 BB Amsterdam (Paesi Bassi) dichiara, sotto la propria responsabilità, che il prodotto Sunshower DELUXE stato fabbricato secondo i requisiti delle seguenti direttive:

- Direttiva LVD 2014/35/EU
- Direttiva 2014/30/EU per compatibilità Elettromagnetica della Comunità Europea

E in conformità con le seguenti norme:

- EN60335-1:2012 + A11:2014 + AC2014 + A13:2017 + A1:2019
+ A2:2019 + A14:2019
- EN60335-2-27:2014 + A1:2020 + A2:2020
- EN61000-6-3:2007 + A1:2011 + AC:2012
- EN61000-6-1:2007
- EN61000-6-1:2019
- EN61000-3-3:2013
- EN61000-3-2:2014

Questo prodotto Sunshower è certificato IPX5 e sviluppato appositamente per l'uso e l'installazione nella doccia (zona 1).

Paesi Bassi, Amsterdam, 1 jan 2020

Firmato in nome e per conto di:



M. Wegdam, Direttore Tecnico



Sunshower B.V.
Hoogoorddreef 63-65
1101 BB Amsterdam
Paesi Bassi

T +31 (0)20 462 14 60
www.sunshower.eu
info@sunshower.nl

PREPARAZIONE

CONTENUTO DELLA SCATOLA

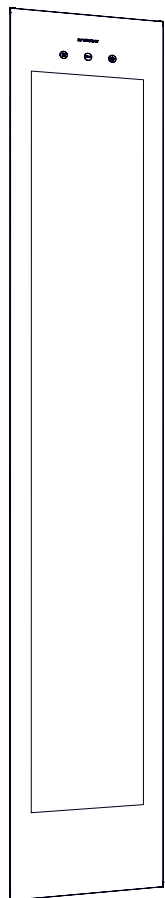

LASTRA DI VETRO

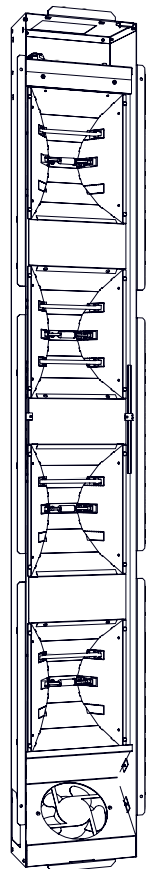

LAVORI INTERNI

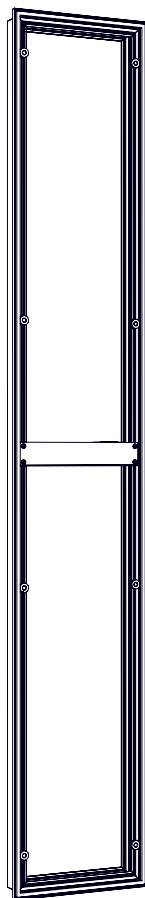

TELAIO A MURO

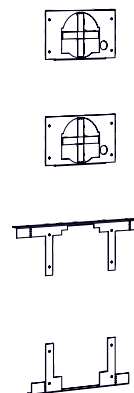

PIASTRE + GIUNTI DI CHIUSURA

NELLA SCATOLA

- Sacchetto di installazione
- 2x Piastre
- 2x Giunti di chiusura
- 2x Occhiali

NON INCLUSO

- Sigillante
- Metro
- Cacciavite (+)
- Livella
- 2x Viti
- 2x Canali di ventilazione (tondi/rettangolari), max 3 m
- 8x Staffe per canalina
- 2x Griglie di ventilazione
- 2x (Valvole di non ritorno)

PREPARAZIONE

DIMENSIONE

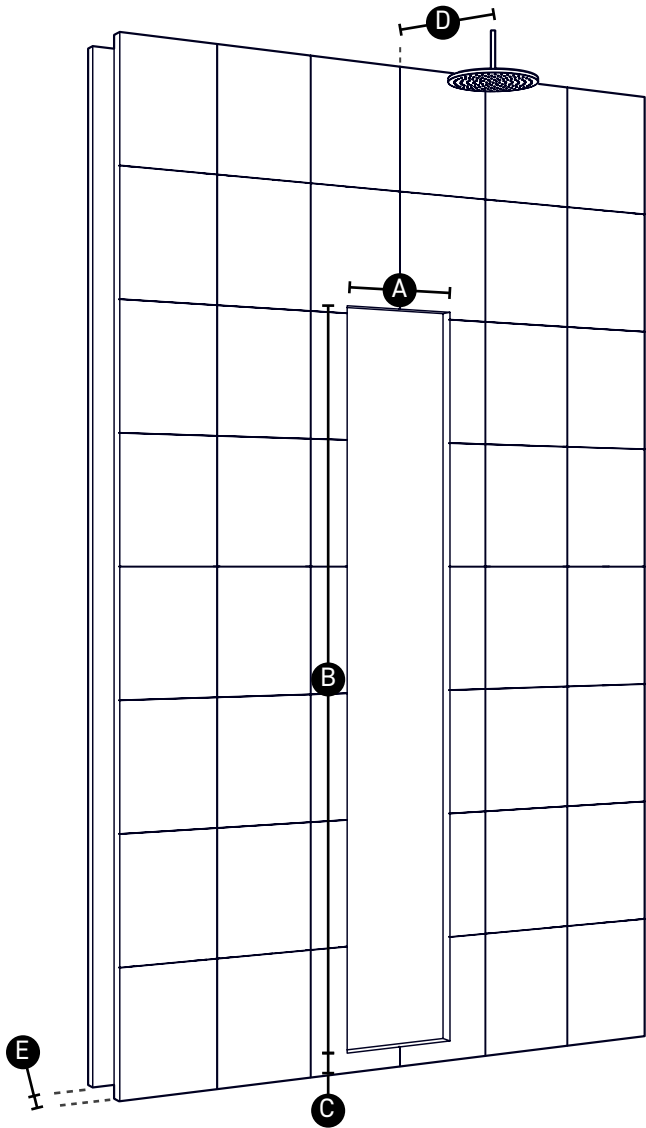

ISTRUZIONI

Tracciare l'intercapedine nel muro seguendo le dimensioni indicate.

STRUMENTI RICHIESTI

- Metro
- Livella

A	300 MM
B	1850 MM
C	100 MM
D	450 MM
E	MIN 165 MM <small>VEDERE P48 / P49</small>

PREPARAZIONE

ELETTRICITÀ

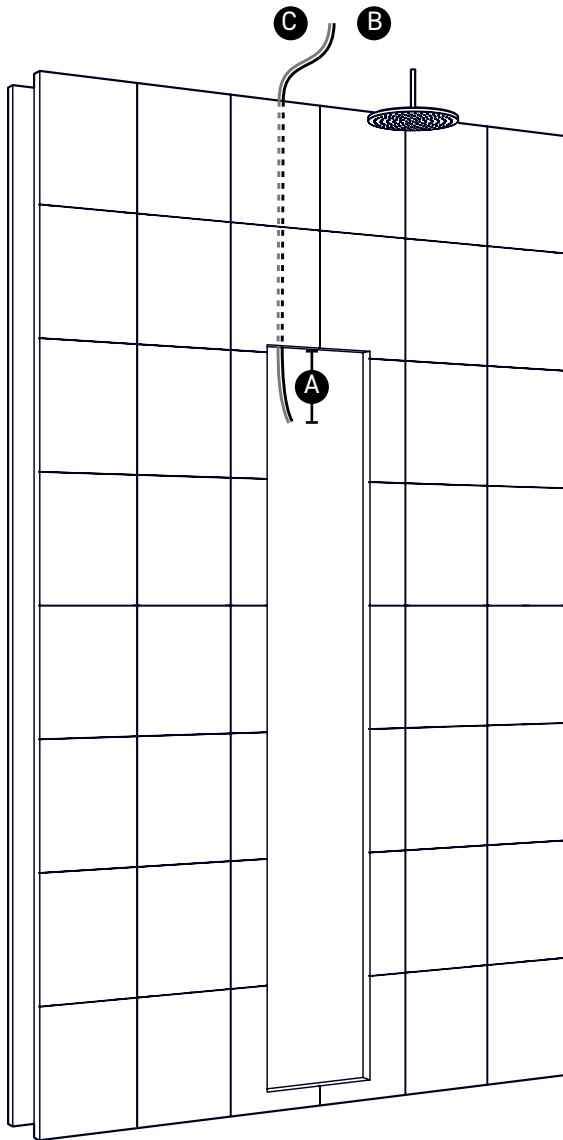

ISTRUZIONI

Utilizzare un cavo YMvK di almeno 2,5 mm² e un cavo di collegamento equipotenziale di 6 mm² senza guaina in PVC o di 2,5 mm² con guaina in PVC. La Sunshower deve essere collegata a un gruppo provvisto di interruttore differenziale, con 230V~50Hz e fusibile da 16A.



ALL ELECTRICAL WORK MUST BE CARRIED OUT BY A QUALIFIED ELECTRICIAN IN ACCORDANCE WITH THE APPLICABLE GUIDELINES (HD 60364-7-701 AND SUCH) AND NATIONAL REGULATIONS.

A SEPARATE POWER CONNECTION WITH A SEPARATE FUSE AND A SEPARATE EARTH LEAKAGE CIRCUIT BREAKER (RCD) MUST BE PROVIDED.

- A** 300 MM
- B** ALIMENTATORE, CAVO A 3 CONDUTTORI
- C** CAVO EQUIPOTENZIALE

PREPARAZIONE

VENTILAZIONE

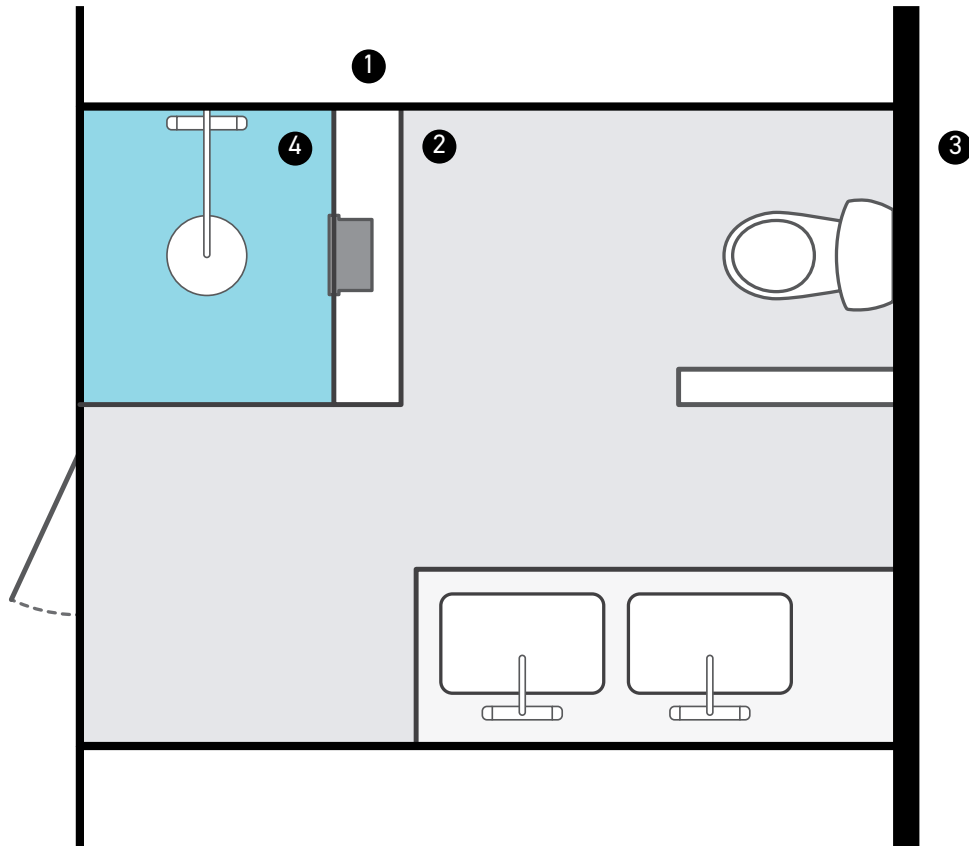

- ① AREA ASCIUTTA
- ② BAGNO
- ③ AL DI FUORI
- ④ ZONA DOCCIA

- A PAGINA 48 *PREFERITO*
- B PAGINA 49
- B PAGINA 49
- *NON POSSIBILE*

ISTRUZIONI

LINEE GUIDA GENERALI PER LA VENTILAZIONE:

- Tutti gli apparecchi Sunshower devono essere installati con condotti di ventilazione
- L'alimentazione e lo scarico della ventilazione possono avere un massimo di 3 m
- Lo spazio da cui viene fornita la ventilazione deve essere di almeno 12 m³
- I condotti possono essere di qualsiasi materiale, con dimensioni Ø100 mm o 110 * 55 mm
- Crea il minor numero possibile di curve nei tubi
- Il Sunshower potrebbe non essere collegato a un sistema di ventilazione esistente

VALVOLE DI NON RITORNO:

Le valvole di non ritorno devono essere installate se l'aria per il Sunshower viene estratta da un'area umida, ad es. dall'esterno o dal bagno. Per le istruzioni, fare riferimento all'immagine e alle pagine successive. Le valvole di non ritorno possono essere ordinate in aggiunta (come set con i pannelli di vetro) o acquistabili separatamente nel tuo negozio di ferramenta.

Esempi di aree umide:
bagno esterno.

Esempi di aree asciutte:
camera da letto, corridoio, bagno.

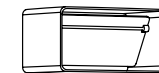

VALVOLA DI
NON RITORNO
RETTANGOLARE

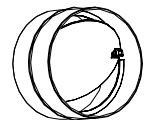

VALVOLA DI NON
RITORNO TONDA

INSTALLAZIONE

A AREA ASCIUTTA

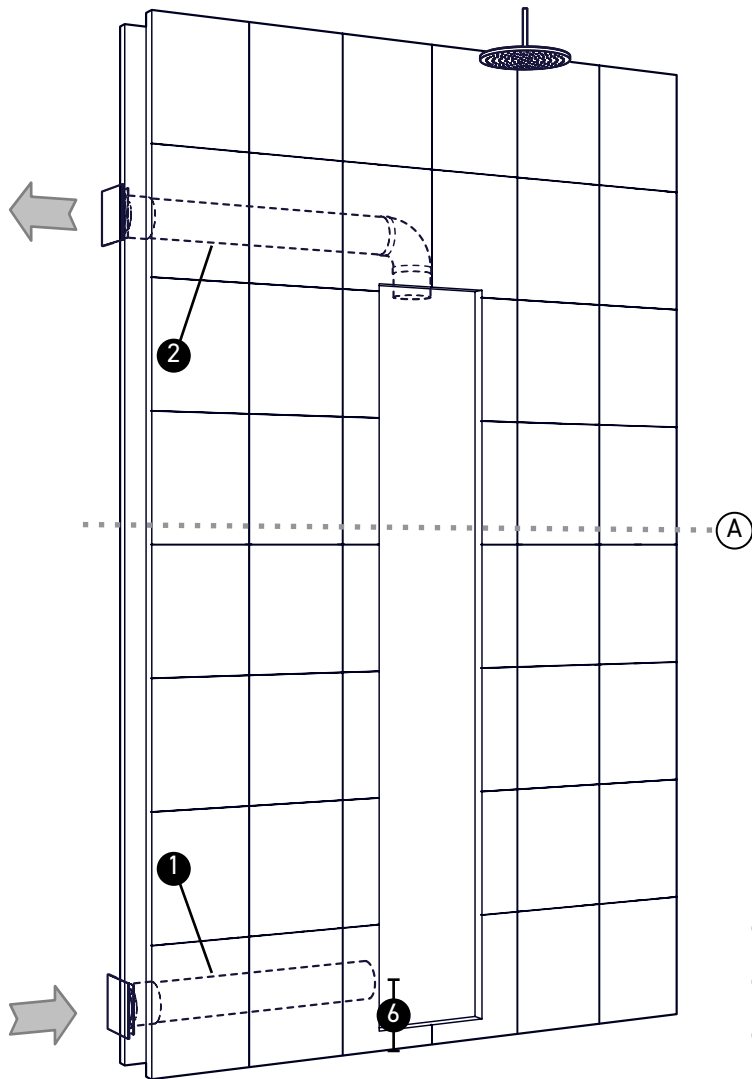

- 1 Alimentazione
- 2 Carico
- 3 Parete di fondo
- 4 Isolamento opzionale
- 5 Costruzione di pareti (Cartongesso / piastrelle / parete vuota)

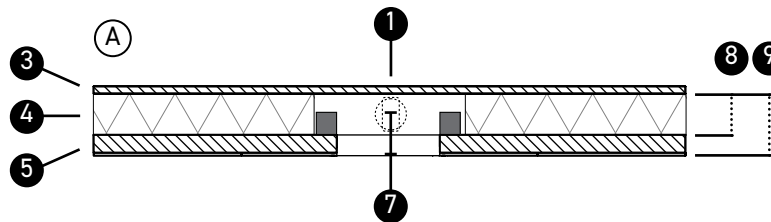

ISTRUZIONI

Installare tubi di ventilazione di almeno $\varnothing 100$ mm o 110x54 mm, di lunghezza massima di 3 m (sia per l'alimentazione che per lo scarico). L'area di ventilazione deve essere di almeno 12 m³.

Le valvole di non ritorno, in questo caso, non sono obbligatorie.

STRUMENTI RICHIESTI

- 2x □ Canali di ventilazione
- 8x □ Staffe per canalina
- 1x □ Set di griglie di ventilazione (disponibili a parte)
- 2x Griglie di ventilazione

Dimensioni minime interne (8)
condotti rotondi: 110 mm
Dimensioni interne minime
(8) condotti rettangolari:
70 mm

- 6 210 MM
- 7 100 MM
- 8 70 MM MIN.
- 9 170 MM MIN.

INSTALLAZIONE

B AREA UMIDA

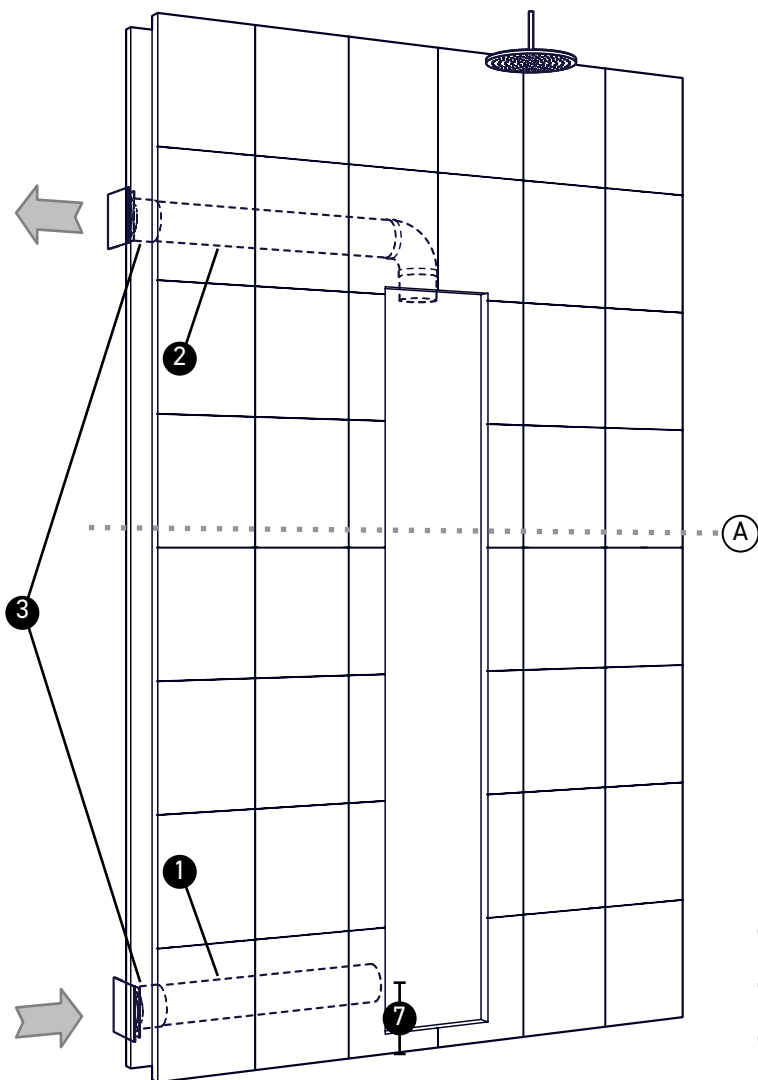

- 1 Alimentazione
- 2 Carico
- 3 Valvole di non ritorno
- 4 Parete di fondo
- 5 Isolamento opzionale
- 6 Costruzione di pareti
(Cartongesso /
piastrelle / parete
vuota)

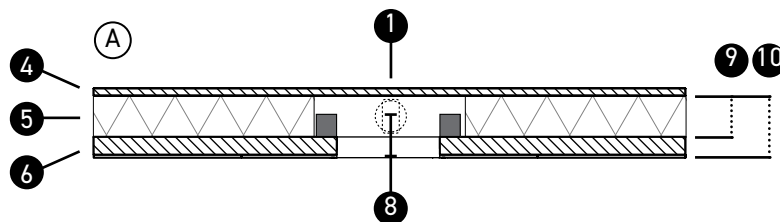

ISTRUZIONI

Installare tubi di ventilazione di almeno $\varnothing 100$ mm o 110x54 mm, di lunghezza massima di 3 m (sia per l'alimentazione che per lo scarico). L'area di ventilazione deve essere di almeno 12 m³.

Le valvole di non ritorno, in questo caso, sono obbligatorie.

STRUMENTI RICHIESTI

- 2x Canali di ventilazione
- 8x Staffe per canalina
- 1x Set di griglie di ventilazione
(disponibili a parte)
- 2x Griglie di ventilazione
- 2x Valvole di non ritorno

Dimensioni minime interne (9)
condotti rotondi: 110 mm
Dimensioni interne minime
(9) condotti rettangolari:
70 mm

- 7 210 MM
- 8 100 MM
- 9 70 MM MIN.
- 10 170 MM MIN.

INSTALLAZIONE

TELAIO A MURO

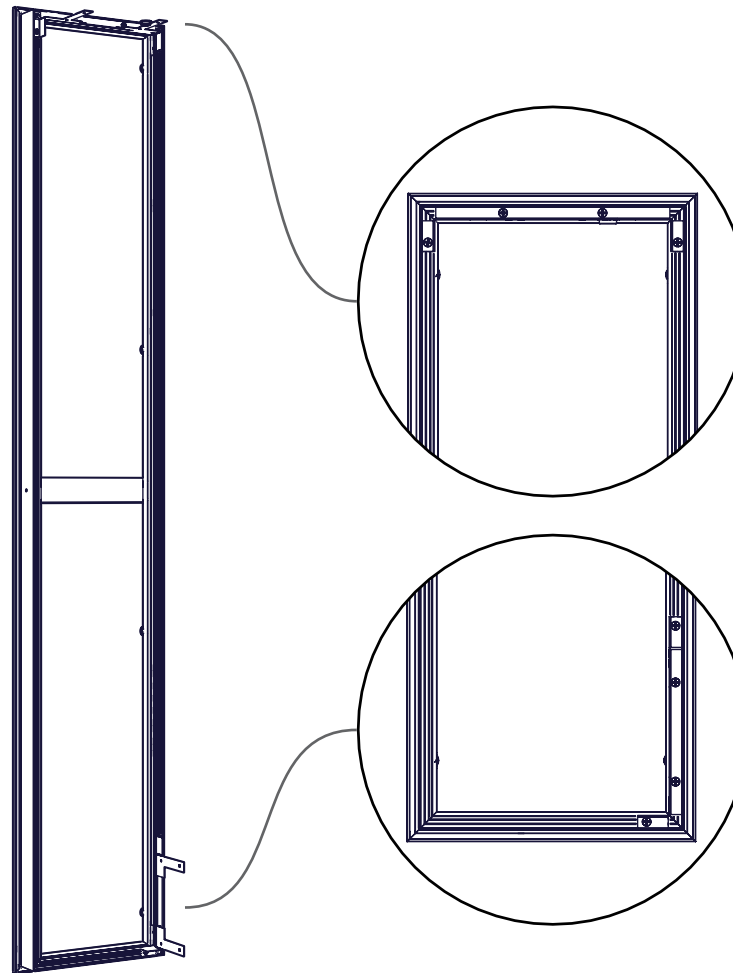
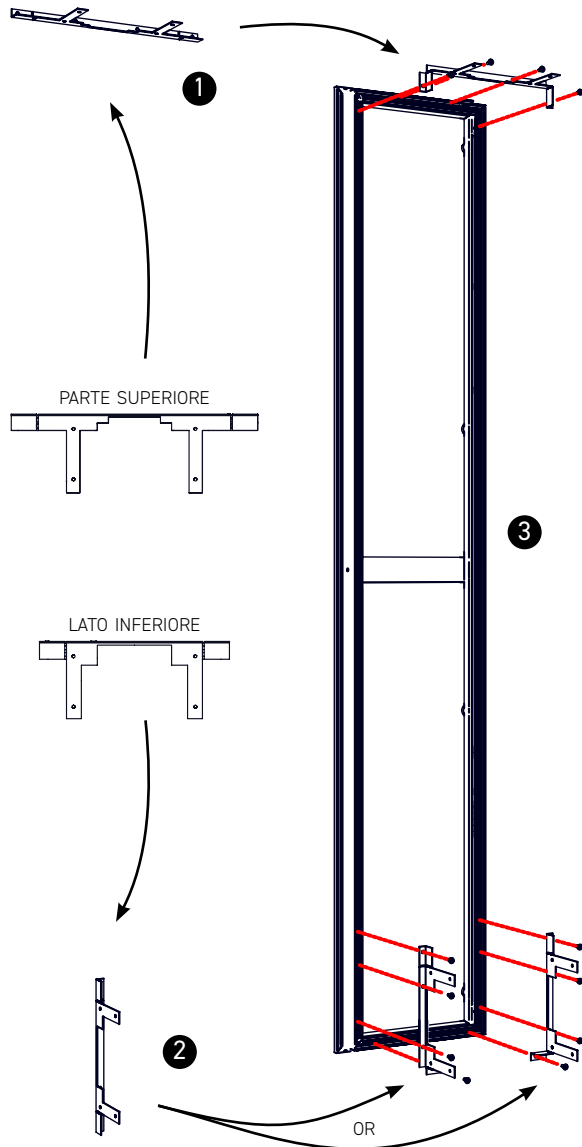

ISTRUZIONI

- 1 Piegare la piastra superiore come indicato
- 2 Piegare la piastra inferiore come indicato, a seconda del lato in cui si trova la bocchetta di ventilazione
- 3 Montare entrambe le piastre sulla parte superiore e inferiore del telaio come indicato, utilizzando le viti fornite

STRUMENTI RICHIESTI

- Cacciavite (+)
- 2x □ Piastre
- 8x □ Viti

INSTALLAZIONE

TELAIO A MURO

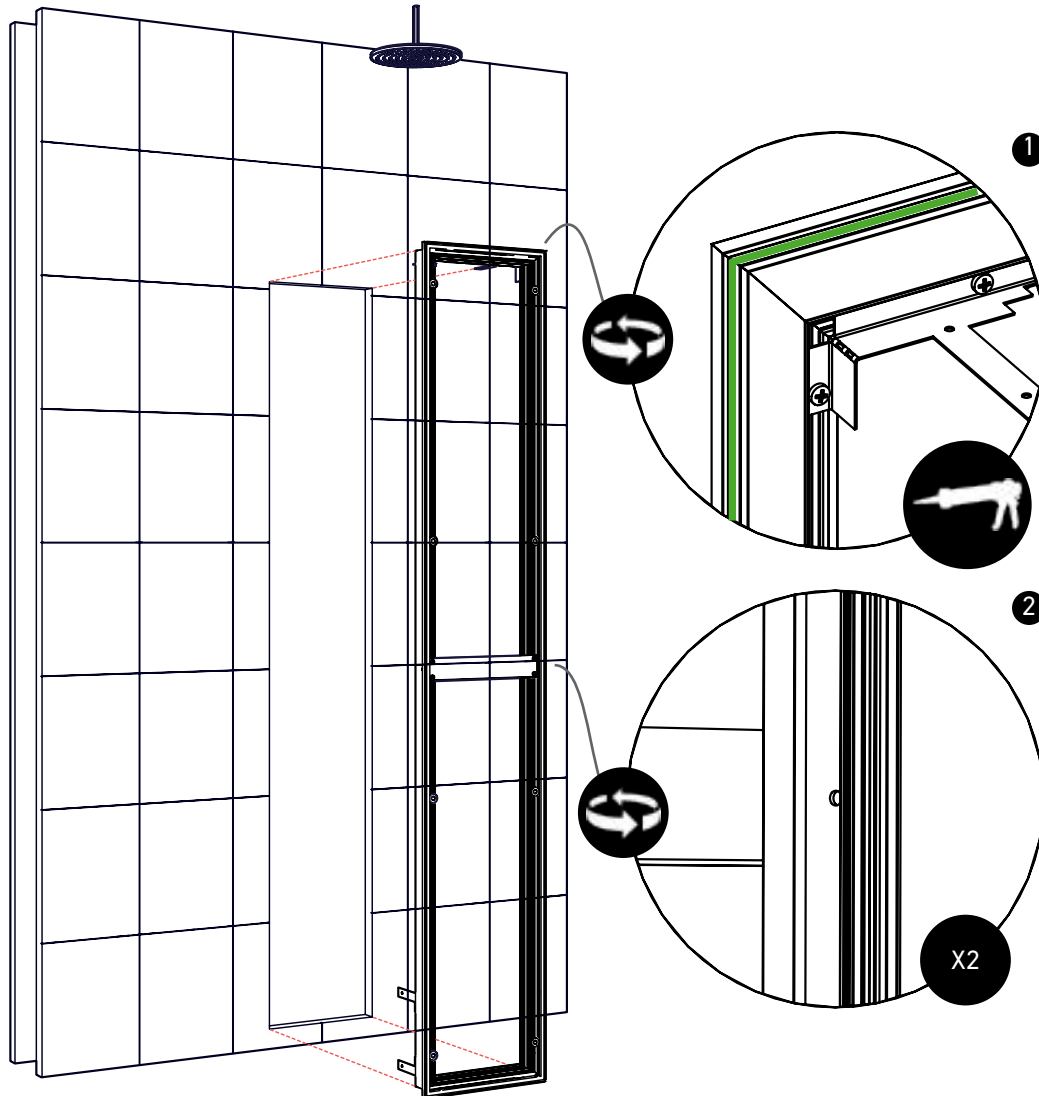

ISTRUZIONI

Rifinire completamente la parete prima di posizionare il telaio, in modo da ottenere un risultato ottimale.

Quindi installare il telaio:

- 1 Applicare il sigillante lungo il perimetro del telaio sulla parete
Avvitare il telaio sulla parete
- 2 (anteriore), da entrambi i lati

REQUIRED TOOLS

- Sigillante
- Cacciavite (+)
- 2x □ Viti



ATTENZIONE:

Queste istruzioni sono importanti per garantire il sigillo IPX5

INSTALLAZIONE

TELAIO A MURO

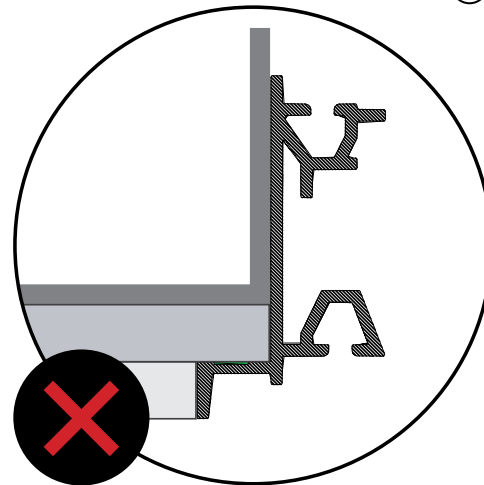
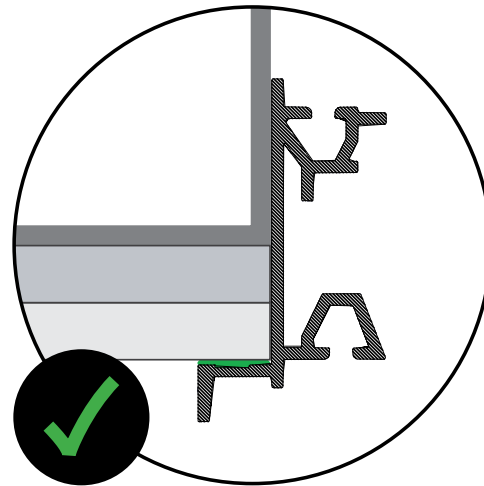
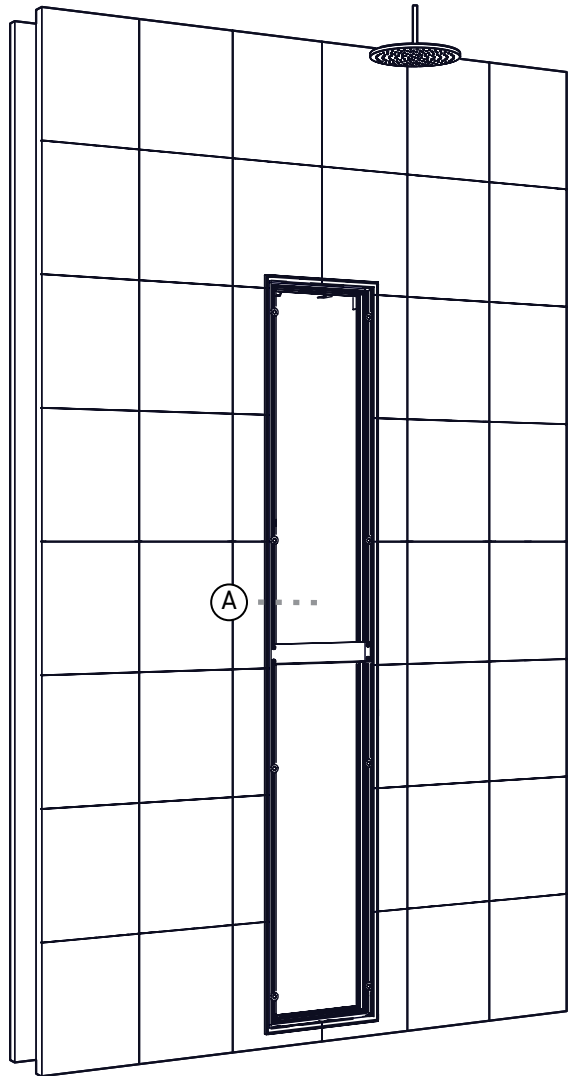

Assicurarsi che i telai siano montati sulla parete anziché a filo con il muro. Questo per garantire la tenuta stagna della Sunshower.

INSTALLAZIONE

TELAIO A MURO

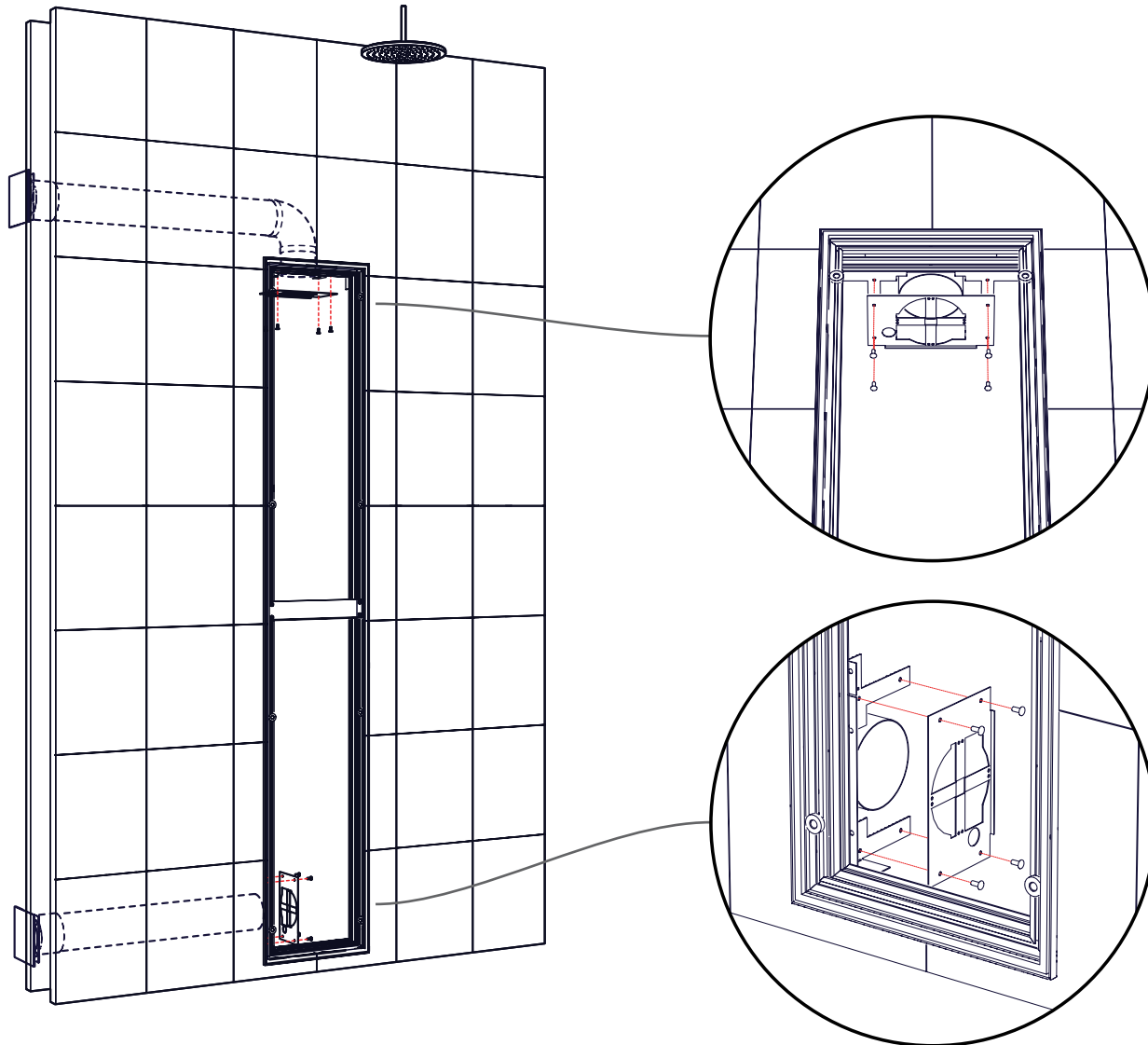

ISTRUZIONI

Collegare i giunti di chiusura alle piastre utilizzando i rivetti a pressione. Piegare i bordi dei giunti di chiusura e farli scorrere nei tubi di ventilazione.

La parte 1 dell'installazione è terminata. Lasciare asciugare il sigillante per 24 ore prima di iniziare la parte 2.

STRUMENTI RICHIESTI

- 2x □ Giunti di chiusura
- 8x □ Rivetti a pressione



DELUXE
WHITE / BLACK / ORGANIC GREY

MANUEL D'INSTALLATION

PARTIE ❶ - PRÉPARATION

INSTRUCTIONS GÉNÉRALES



GÉNÉRAL

LISEZ ATTENTIVEMENT CETTE INSTRUCTION AVANT DE PROCÉDER À L'INSTALLATION. L'INSTALLATION NE PEUT ÊTRE EFFECTUÉE QUE PAR DES INSTALLATEURS QUALIFIÉS. LE RACCORDEMENT ÉLECTRIQUE DES COMPOSANTS DE DOUCHE SOLAIRE NE PEUT ÊTRE EFFECTUÉ QUE PAR DES ÉLECTRICIENS QUALIFIÉS. SUNSHOWER N'EST PAS RESPONSABLE DES DOMMAGES CAUSÉS PAR UNE INSTALLATION INCORRECTE.



ÉLECTRICITÉ

LE RACCORDEMENT ÉLECTRIQUE DES ÉLÉMENTS DE DOUCHE SOLAIRE NE DOIT ÊTRE EFFECTUÉ QUE PAR UN ÉLECTRICIEN QUALIFIÉ. L'INSTALLATION ET LE RACCORDEMENT ÉLECTRIQUE DE L'INSTALLATION DE DOUCHE SOLAIRE DOIVENT ÊTRE EFFECTUÉS CONFORMÉMENT AUX NORMES ET DIRECTIVES INTERNATIONALES ET NATIONALES APPLICABLES. LA DOUCHE SOLAIRE DOIT ÊTRE PROTÉGÉE PAR UN DISJONCTEUR DIFFÉRENTIEL SÉPARÉ (RCD) (VOIR RACCORDEMENT ÉLECTRIQUE).

Sunshower B.V.
Hoogoorddreef 63-65
1101 BB Amsterdam
Les Pays-Bas

T +31 (0)20 462 14 60
www.sunshower.eu
info@sunshower.nl

DÉCLARATION DE CONFORMITÉ

Sunshower B.V., Hoogoorddreef 63-65, 1101 BB Amsterdam (Les Pays-Bas) déclarons que le produit Sunshower DELUXE est conforme aux dispositions des Directives suivantes:

- Directive 89/336/CEE de la Communauté européenne
- Directive sur les basses tensions 2006/95/CE de la Communauté européenne

Et des normes suivantes:

- EN60335-1:2012 + A11:2014 + AC2014 + A13:2017 + A1:2019 + A2:2019 + A14:2019
- EN60335-2-27:2014 + A1:2020 + A2:2020
- EN61000-6-3:2007 + A1:2011 + AC:2012
- EN61000-6-1:2007
- EN61000-6-1:2019
- EN61000-3-3:2013
- EN61000-3-2:2014

Ce produit Sunshower est certifié IPX5 et spécialement développé pour une utilisation et une installation dans la douche (zone 1).

Les Pays-Bas, Amsterdam, 1 jan 2020

Signé pour et au nom de:



M. Wegdam, Directeur Technique



Sunshower B.V.
Hoogoorddreef 63-65
1101 BB Amsterdam
Les Pays-Bas

T +31 (0)20 462 14 60
www.sunshower.eu
info@sunshower.nl

PRÉPARATION

COMPOSANTS DE LA BOÎTE

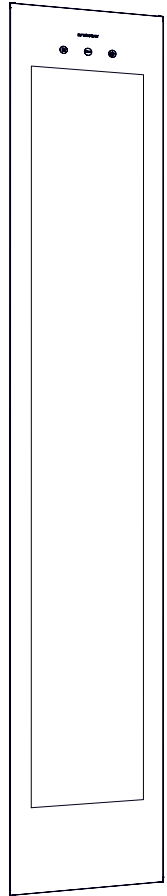

PANNEAU DE VERRE

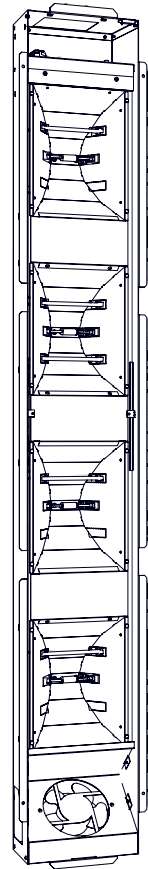

UNITÉ INTÉRIEURE

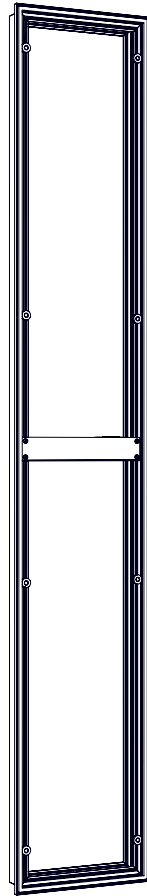

CADRE DE LA PAROI

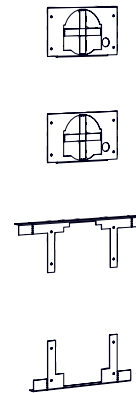

GOUSSETS EN TÔLE
+ MANCHONS DE
RACCORDEMENT

DANS LA BOÎTE

- Sachet d'installation
- 2x Goussets en tôle
- 2x Manchons de raccordement
- Lunettes
- 2x

NON INCLUS

- Mastic
- Mètre ruban
- Tournevis (+)
- Niveau
- 2x Vis
- 2x Conduits de ventilation (ronds/rectangulaires), max. 3 m
- 8x Supports de conduit
- 2x Grilles de ventilation
- 2x (Clapets antiretours)

PRÉPARATION

DIMENSIONS

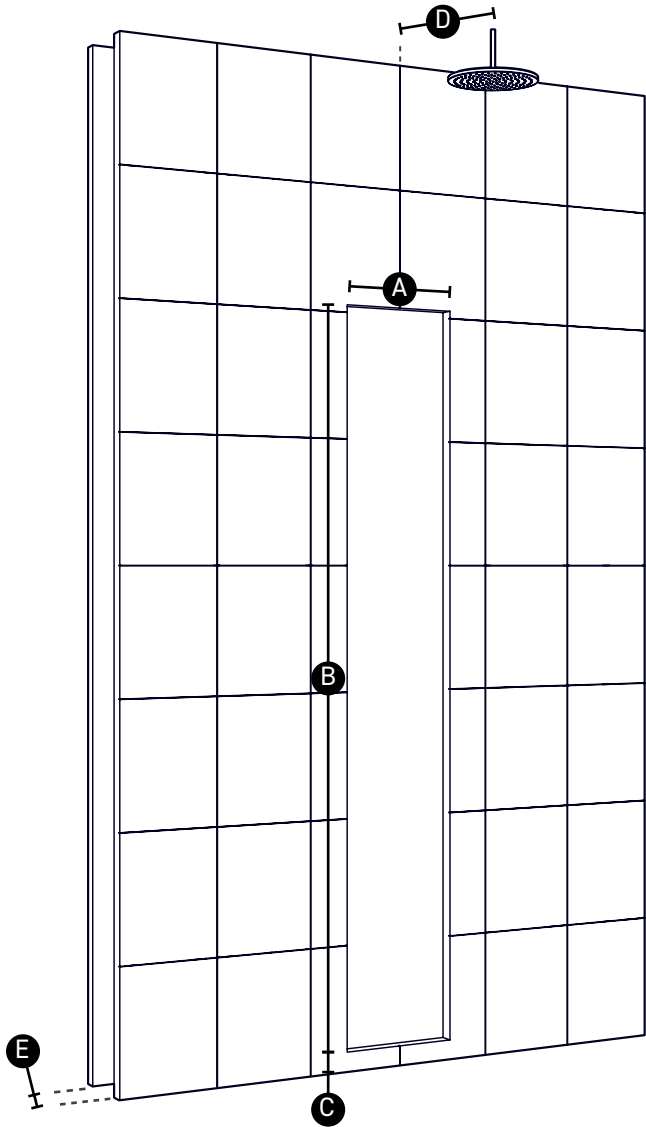

INSTRUCTIONS

Pratiquez l'évidement dans le mur en respectant les dimensions indiquées.

MATÉRIEL NÉCESSAIRE

- Mètre ruban
- Niveau

A	300 MM
B	1850 MM
C	100 MM
D	450 MM
E	MIN 165 MM <small>VOIR P61 / P62</small>

PRÉPARATION

ÉLECTRICITÉ

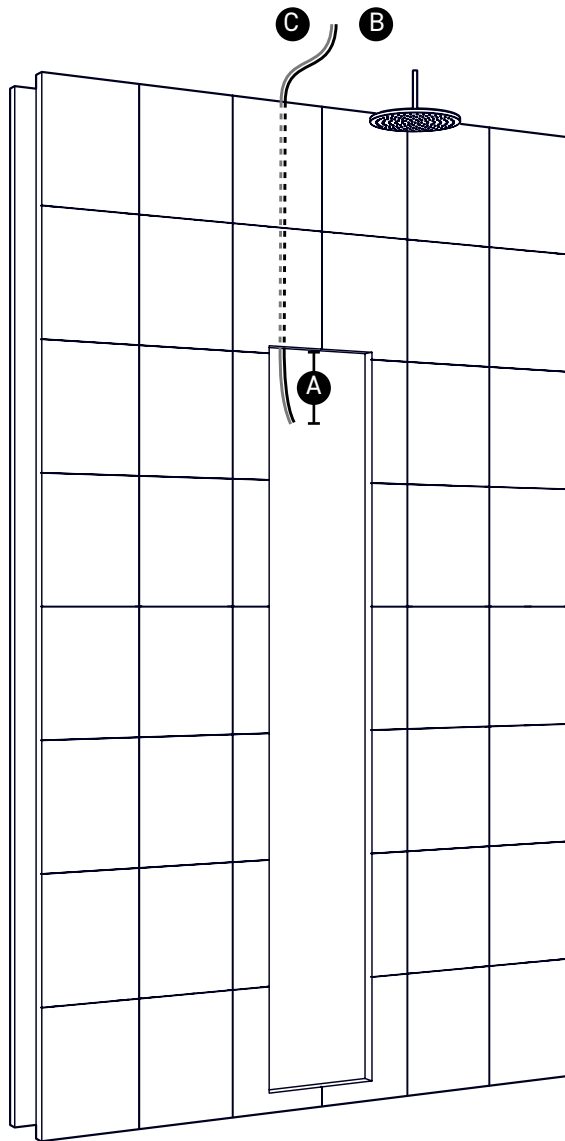

INSTRUCTIONS

Prévoyez un câble YMvK d'au moins 2,5 mm² et un câble de liaison équipotentielle de 6 mm² sans tuyau en PVC ou de 2,5 mm² avec tuyau en PVC. Le Sunshower doit de être relié à un circuit propre de 230 V et 50 Hz équipé d'un interrupteur à courant différentiel résiduel et d'un fusible de 16 A.



TOUS LES TRAVAUX ÉLECTRIQUES DOIVENT ÊTRE EFFECTUÉS PAR UN ÉLECTRICIEN QUALIFIÉ CONFORMÉMENT AUX DIRECTIVES APPLICABLES (HD 60364-7-7-701 ET AUTRES) ET AUX RÉGLEMENTATIONS NATIONALES. UN RACCORDEMENT D'ALIMENTATION SÉPARÉ AVEC UN FUSIBLE SÉPARÉ ET UN DISJONCTEUR DIFFÉRENTIEL SÉPARÉ (RCD) DOIT ÊTRE PRÉVU.

- A** 500 MM
- B** CÂBLE D'ALIMENTATION, CÂBLE TRIPOLAIRE
- C** CÂBLE DE LIAISON ÉQUIPOTENTIELLE

PRÉPARATION

VENTILATION

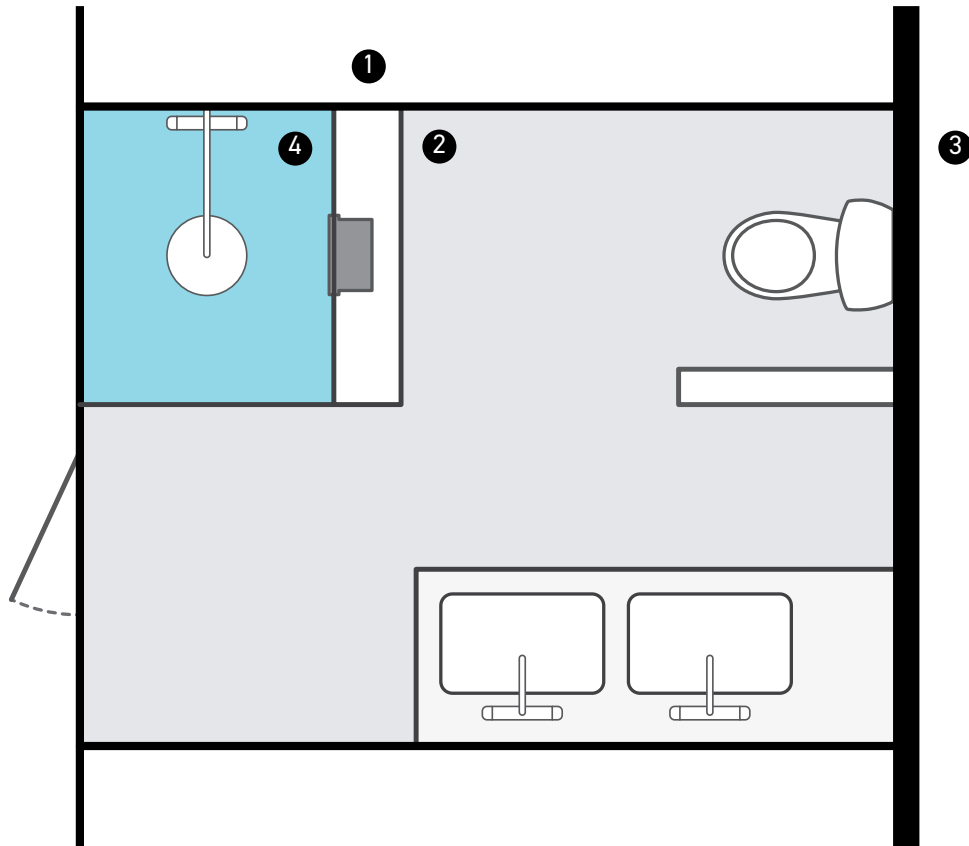

- ① ENDROIT SEC
- ② SALLE DE BAINS
- ③ À L'EXTÉRIEUR
- ④ COIN DOUCHE

- A PAGE 61 PRIVILÉGIÉS
- B PAGE 62
- B PAGE 62
- IMPOSSIBLE

INSTRUCTIONS

DIRECTIVES GÉNÉRALES DE CONSTRUCTION:

- Tous les appareils Sunshower doivent être installés avec des conduits de ventilation.
- L'arrivée et l'évacuation de l'air d'aération peuvent être au maximum de 3 m.
- L'espace à partir duquel/vers lequel la ventilation est assurée doit être d'au moins 12 m³.
- Les gaines peuvent être de n'importe quel matériau, avec des dimensions Ø100 mm ou 110 * 55 mm.
- Faire le moins de coudes possible dans les gaines.
- La douche solaire ne doit pas être raccordée à un système de ventilation existant.

CLAPETS ANTIRETOURS:

Des clapets antiretour doivent être installés si l'air de votre douche solaire est extrait d'un endroit humide, par exemple de l'extérieur ou de la salle de bains. Veuillez vous référer à l'image et aux pages suivantes pour les instructions. Les clapets antiretour peuvent être commandés en plus (en kit avec les panneaux de verre) ou achetés séparément dans votre quincaillerie.

Exemples de zones humides :
salle de bain, à l'extérieur.

Exemples de zones sèches :
chambre, couloir, toilettes.

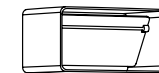

CLAPET
ANTIRETOUR
RECTANGULAIRE

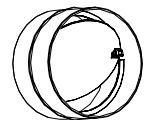

CLAPET
ANTIRETOUR
ROND

INSTALLATION

A ENVIRONNEMENT SEC

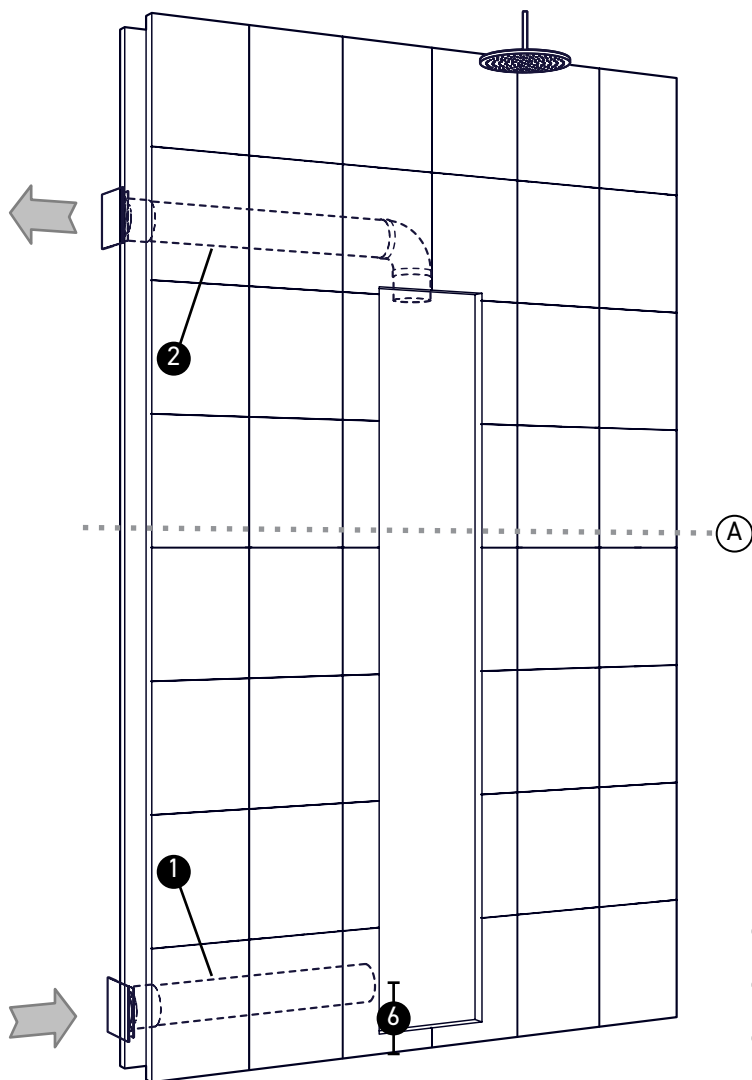

- 1 Alimentation
- 2 Évacuation
- 3 Paroi arrière
- 4 Isolation en option
- 5 Construction de murs (cloison sèche/ carreaux/cloison creuse)

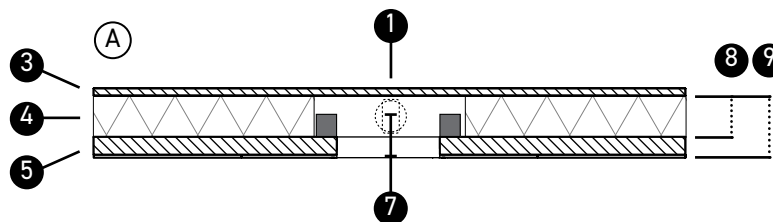

INSTRUCTIONS

Installez des conduits de ventilation de $\varnothing 100$ mm ou de 110 x 54 mm au minimum ne dépassant pas 3 m de long (aussi bien pour l'alimentation que pour l'évacuation). L'alimentation de la ventilation doit disposer d'un espace de 12 m³ au minimum.

Dans ce cas, les clapets antiretour ne sont pas obligatoires.

MATÉRIEL NÉCESSAIRE

- 2x □ Conduits de ventilation
 - 8x □ Supports de conduit
 - 1x □ Ensemble de grilles de ventilation (disponibles séparément)
- Grilles de ventilation*
- 2x

Dimensions intérieures minimales (8)

 gaines rondes: 110 mm

Dimensions intérieures minimales (8) conduits rectangulaires: 70 mm

- 6 210 MM
- 7 100 MM
- 8 70 MM MIN.
- 9 170 MM MIN.

INSTALLATION

B ENVIRONNEMENT HUMIDE

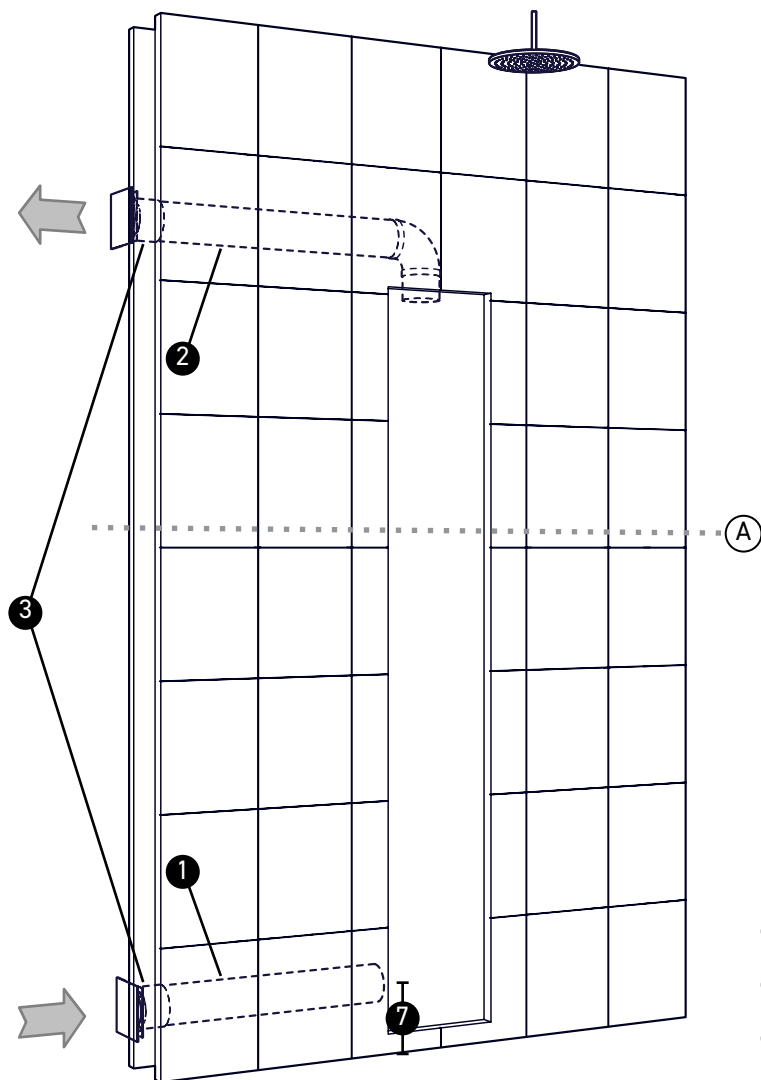

- 1 Alimentation
- 2 Évacuation
- 3 Clapets antiretours
- 4 Paroi arrière
- 5 Isolation en option
- 6 Construction de murs (cloison sèche/ carreaux/cloison creuse)

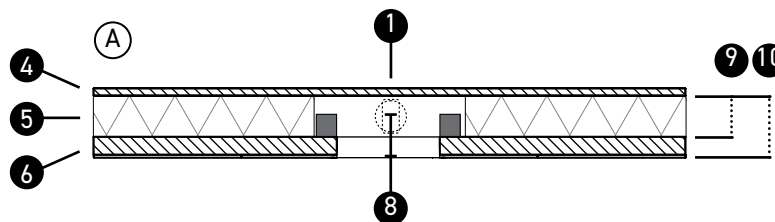

INSTRUCTIONS

Installez des conduits de ventilation de $\varnothing 100$ mm ou de 110 x 54 mm au minimum ne dépassant pas 3 m de long (aussi bien pour l'alimentation que pour l'évacuation). L'alimentation de la ventilation doit disposer d'un espace de 12 m³ au minimum.

Dans ce cas, les clapets antiretour sont obligatoires.

MATÉRIEL NÉCESSAIRE

- 2x Conduits de ventilation
- 8x Supports de conduit
- 1x Ensemble de grilles de ventilation (disponibles séparément)
- 2x Grilles de ventilation
- 2x Clapets antiretours

Dimensions intérieures minimales (9)
 gaines rondes: 110 mm
 Dimensions intérieures minimales
 (9) conduits rectangulaires: 70 mm

- 7 210 MM
- 8 100 MM
- 9 70 MM MIN.
- 10 170 MM MIN.

INSTALLATION

CADRE DE LA PAROI

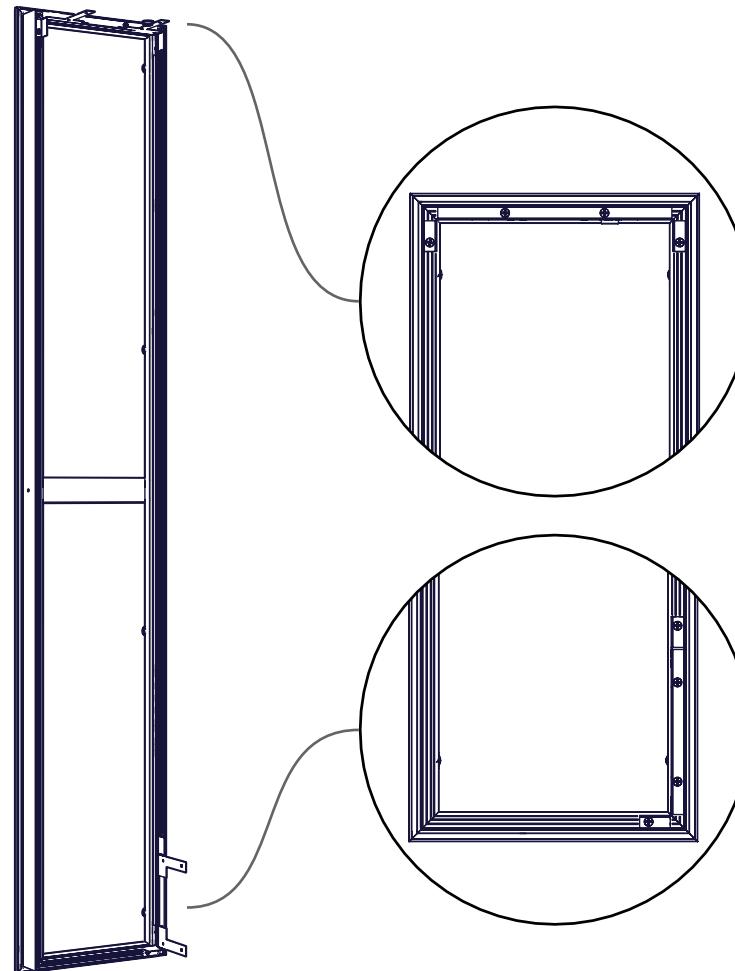
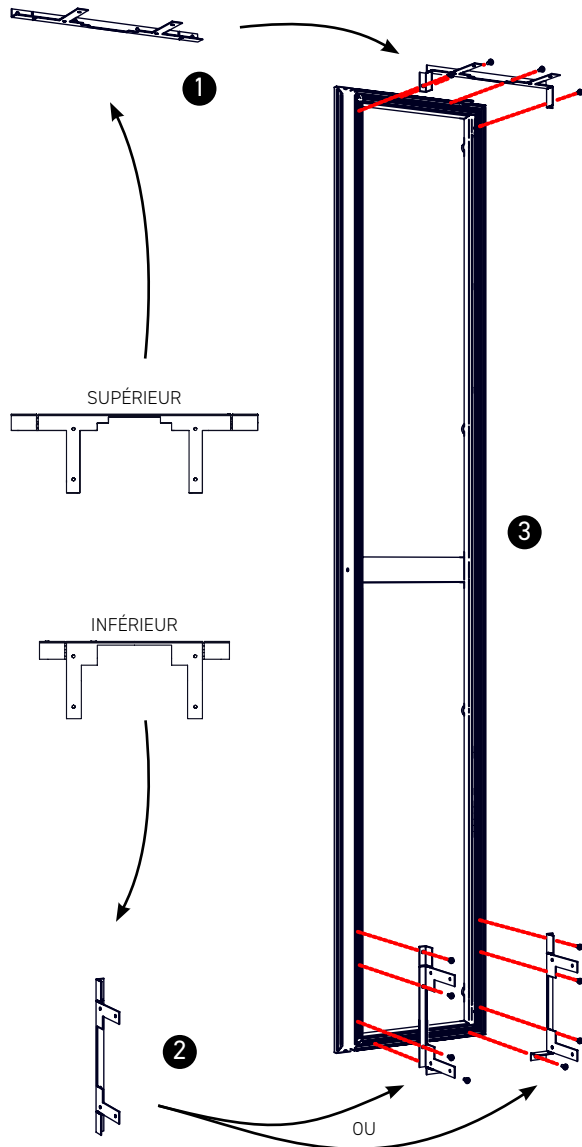

INSTRUCTIONS

- 1 Pliez le gousset en tôle supérieur comme indiqué
- 2 Pliez le gousset en tôle inférieur comme indiqué, en fonction du côté de l'alimentation en ventilation
- 3 Montez les goussets en tôle sur la partie supérieure et inférieure du cadre à l'aide des vis incluses, comme indiqué

MATÉRIEL NÉCESSAIRE

- Tournevis (+)
- 2x □ Goussets en tôle
- 8x □ Vis

INSTALLATION

CADRE DE LA PAROI

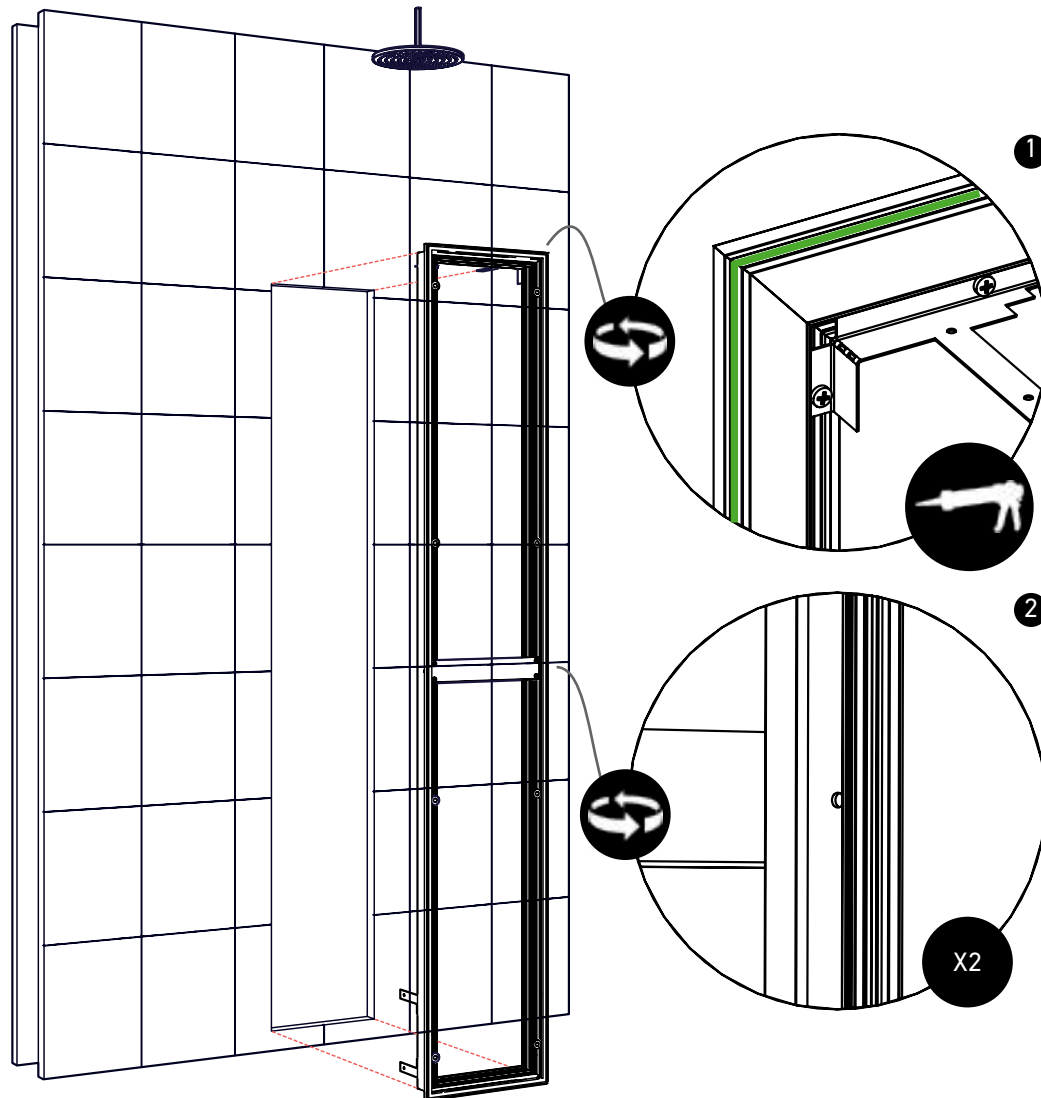

INSTRUCTIONS

Préparez entièrement la paroi avant d'installer les cadres afin d'obtenir le résultat le plus élégant. Ensuite, installez les cadres :

Appliquez du mastic tout autour de

- 1 la face arrière des cadres de la paroi
Vissez les cadres à l'aide des
- 2 supports avec trous oblongs

MATÉRIEL NÉCESSAIRE

- Mastic
- Tournevis (+)
- 2x □ Vis



ATTENTION:

Ces instructions sont importantes pour assurer l'étanchéité de l'IPX5.

INSTALLATION

CADRE DE LA PAROI

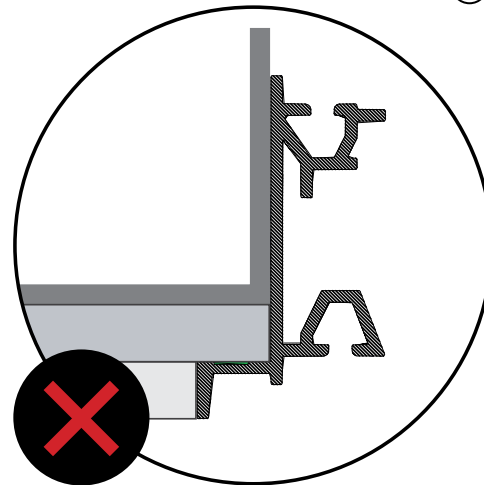
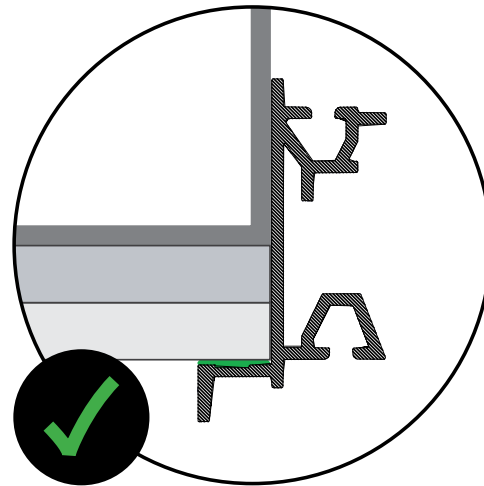
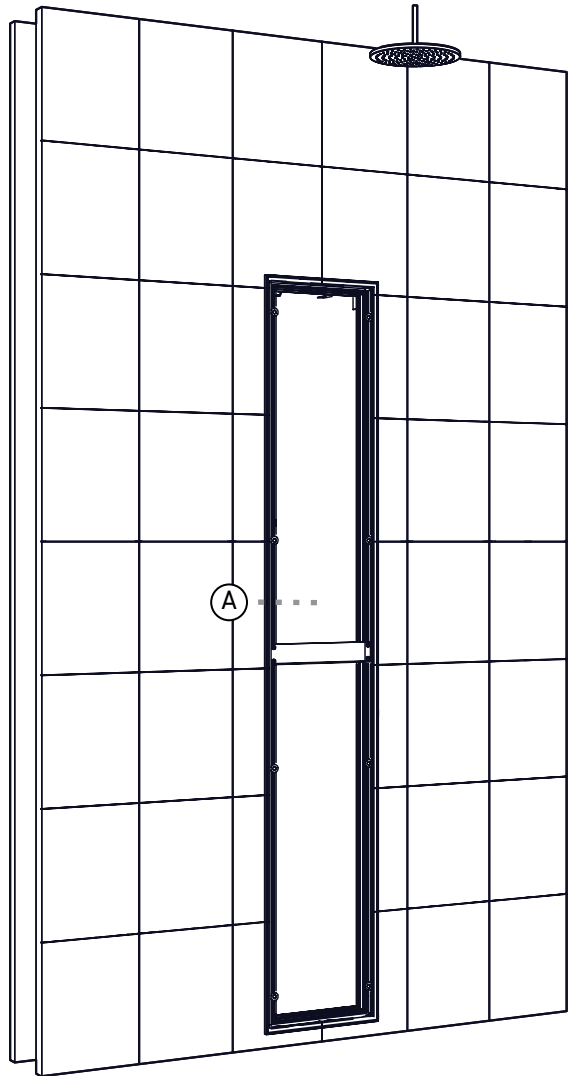

Veillez à ce que les cadres soient montés sur le mur et non encastrés dans ce dernier. Ceci permet de garantir l'étanchéité du Sunshower.

INSTALLATION

CADRE DE LA PAROI

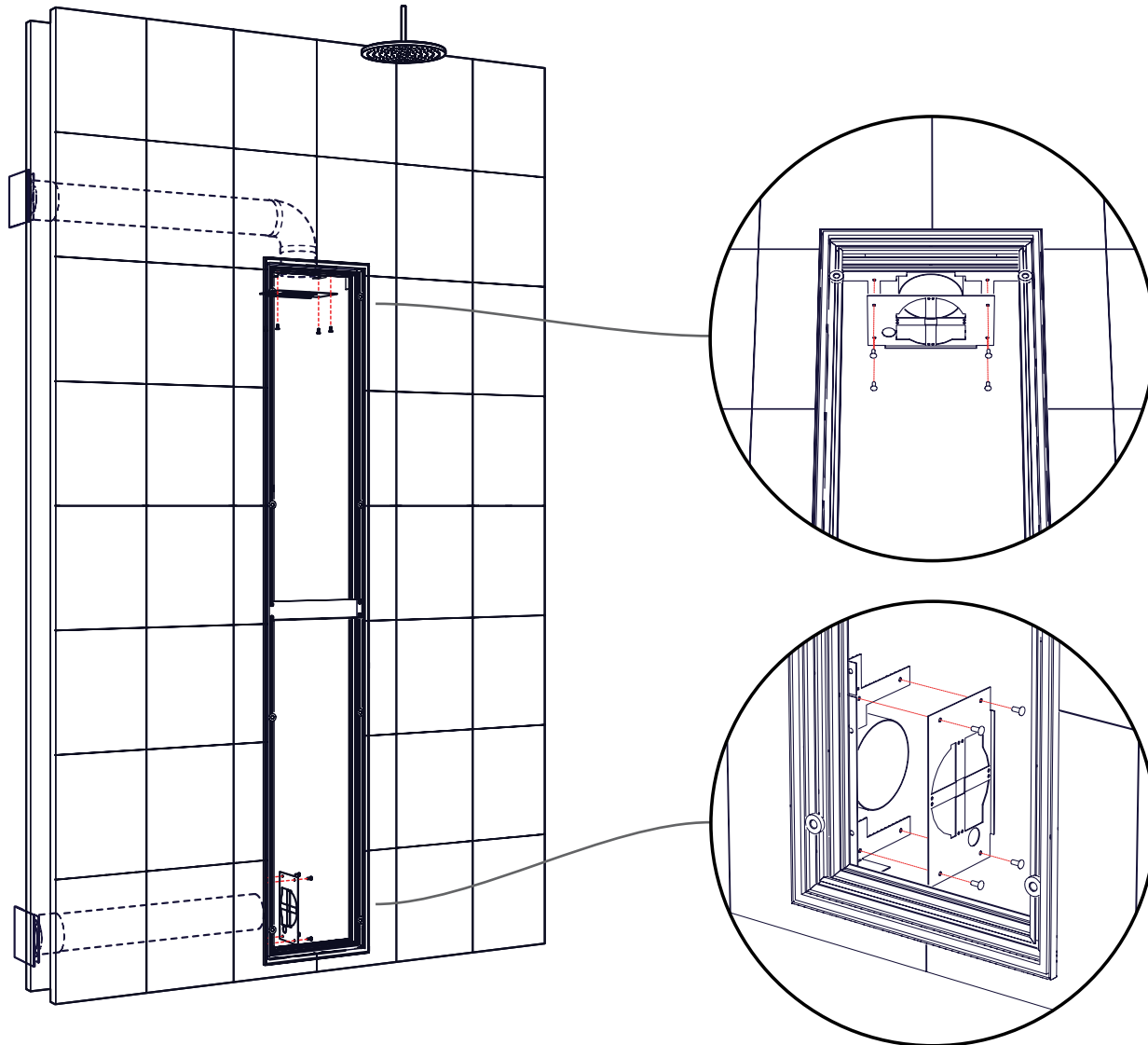

INSTRUCTIONS

Raccordez les manchons sur les goussets en tôle à l'aide des rivets à pousser. Pliez les lèvres des manchons de raccordement et faites-les glisser dans les conduits de ventilation.

Vous avez terminé la première partie de l'installation. Laissez le mastic sécher pendant 24 heures avant de commencer la seconde partie.

MATÉRIEL NÉCESSAIRE

- 2x □ Manchons de raccordement
- 8x □ Rivets à pousser